

MOVITRAC® 31.. Frequency Inverter

Manual
Communications Interfaces
and Parameter List

Edition 12/96



08/141/93

0923 0580 / 0397



SEW EURODRIVE

		PAGE
1	Introduction	4
2	Communications Interfaces	6
2.1	Mode of operation	6
2.1.1	Communications protocol	6
2.1.2	Return codes (RC)	11
2.1.3	Application examples	12
2.2	The RS-232 interface	14
2.2.1	Connecting the MOVITRAC [®] 31.. to a PC	14
2.2.2	Technical data of the RS-232 interface	15
2.3	The RS-485 interface	16
2.3.1	Networking the MOVITRAC [®] 31..	16
2.3.2	Master-slave operation	16
2.3.3	Technical data of the RS-485 interface	17
2.4	Communicating with a PLC	18
2.4.1	System requirements	18
2.4.2	Initializing the PLC module CP523 in the user program	19
2.4.3	Example: Reading the parameter “Heat sink temperature” (P 001)	20
2.4.4	Example: Writing the parameter “T11 RAMP UP” (P 120)	21
3	Data Formats	22
3.1	4-byte BCD format	22
3.2	4-byte binary format	23
3.3	8-byte format	23
4	Parameter List	24
	Display values P 000 - P 079	24
	Setpoints / Ramp generators P 100 - P 185	26
	Frequency characteristics P 200 - P 261	26
	Motor parameters P 310 - P 350	27
	Reference values P 400 - P 471	27
	Monitoring functions P 500 - P 572	28
	Terminal assignment P 600 - P 641	29
	Control functions P 710 - P 779	30
	Special functions P 800 - P 891	31
	Function bits and unit status	32
	Fault memory	34
	IPOS parameters	35
	Appendix: Conversion list Index → Parameter	36

1 Introduction

MOVITRAC[®] 31.. frequency inverters of sizes 1 to 4 have two independent serial interfaces which can be implemented with different SEW options to suit a variety of applications. The interfaces are accessible through connectors X4 (for the operator control options) and X20 (for the option pcbs). The functional independence of the interfaces provides a great degree of flexibility and a wide scope of application. This allows a multitude of different communications concepts to be implemented.

MOVITRAC[®] 31.. frequency inverters of size 0 have only one serial interface on connector X4. Connector X20 is not available on these units.

Figure 1 below shows the options for operator control and serial communications.

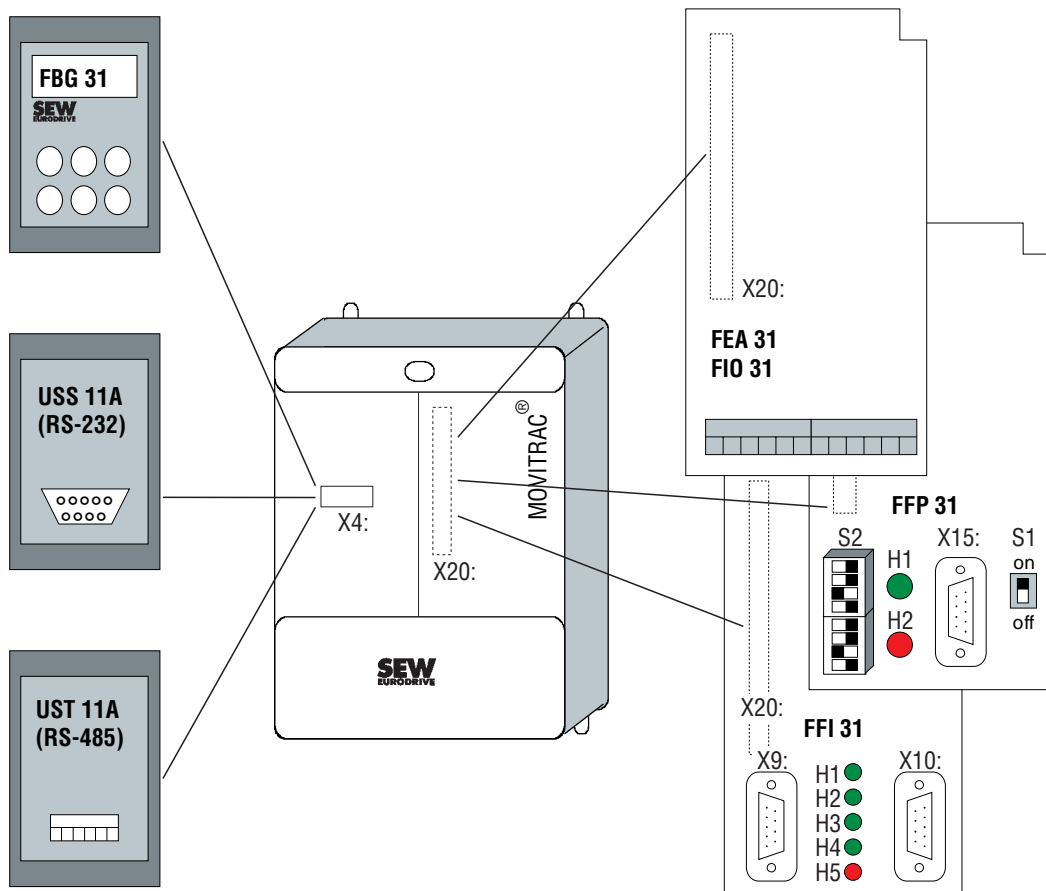

00694AXX

Figure 1: Serial and user interface options with mounting positions shown

Connector X4 for the operator control options is brought out as an RS-485 interface on the front panel of the unit. It can accommodate the following options:

FBG31:

Keypad for adjustment of the frequency inverter parameters (except IPOS parameters/program) and display of current process data. A FKG 31 extension cable is also available for the keypad.

USS 11A (Techn. data → Sec. 2.2.2):

Converts the internal signal level to **RS-232** signal level. An automation unit (PLC) or a PC can be connected to the 9-pin type D socket with a standard interface cable. This enables the user to set parameters or control the inverter (e.g. with the MC_SHELL user interface).

UST 11A (Techn. data → Sec. 2.3.3):

Makes the **RS-485** signals of the X4 interface accessible at the terminal strip of the UST 11A. The main use of this option is to network up to 32 inverters via the X4 interface or to connect the inverter to an automation unit (PLC) with an RS-485 interface.

The **X20 option connector** can accommodate the following options:

FEA 31...:

Offers the following additional I/Os: 1 analog input, 2 analog outputs, 4 binary inputs, 2 binary outputs and a second RS-485 serial interface (terminals 67/68). This interface is mainly used to network several inverters to a higher-level automation unit and to implement master-slave operation.

FIO 31...:

Offers the following additional I/Os: 7 binary inputs, 6 binary outputs and a second RS-485 serial interface (terminals 67/68). This option is mainly used to extend the number of I/Os for applications with the "IPOS positioning control" (FPI 31) option.

FFI 31...:

This option provides an InterBus-S interface to DIN 19258 specifications which offers fast process data transfer and allows the inverter parameters to be set completely via InterBus-S. For a detailed description of this option please refer to the appropriate manual.

FFP 31...:

This option provides a Profibus interface (DP, FMS slave) to DIN 19245 specifications which allows the inverter to be controlled and parameters set completely via Profibus. For a detailed description of this option please refer to the appropriate manual.

Important:

When communicating via the fieldbus interfaces (FFI 31/FFP 31) 1000_{dec} must be added to each index value.

This manual deals with the function and mode of operation of both serial interfaces. It discusses the communications protocol in detail and provides examples to illustrate the use of the protocol (→ Sec. 2). It further includes the complete parameter list (→ Sec. 4).

For a detailed description of the fieldbus interfaces and the fieldbus unit profile please refer to the fieldbus documentation package, part number 0922 7210.

2 Communications Interfaces

2.1 Mode of operation

The two serial interfaces (X4 and X20) allow the inverter to be completely parameterized. They further offer the possibility of reading all internal and external states of the unit (actual values, terminal signals) and of controlling the inverter. Both interfaces work independently of one another and have equal priority. This means that if the inverter is parameterized via both interfaces at the same time, the last value which is sent will be the one which is effective.

Both interfaces use the same transmission protocol. Communication is based on the master-slave principle, whereby the higher-level control (PC, PLC) assumes the role of the master and the inverter takes over the slave function. This means that the drive itself cannot initiate any transmission activity, but can only respond to interrogation by the master. The master always has control of the communications connection.

2.1.1 Communications protocol

The protocol was designed with regard to the following conditions:

- Shortest possible message lengths to achieve short response times
- Low implementation requirements and simple portability to other systems
- Transmission of unit-independent data formats
- Limitation of data integrity in favor of fast protocol execution
- Ability to increase amount of data to be transmitted to accommodate the expected functional enhancement of the unit
- Acyclic, acknowledged data traffic to minimize time-related demands on the drive.

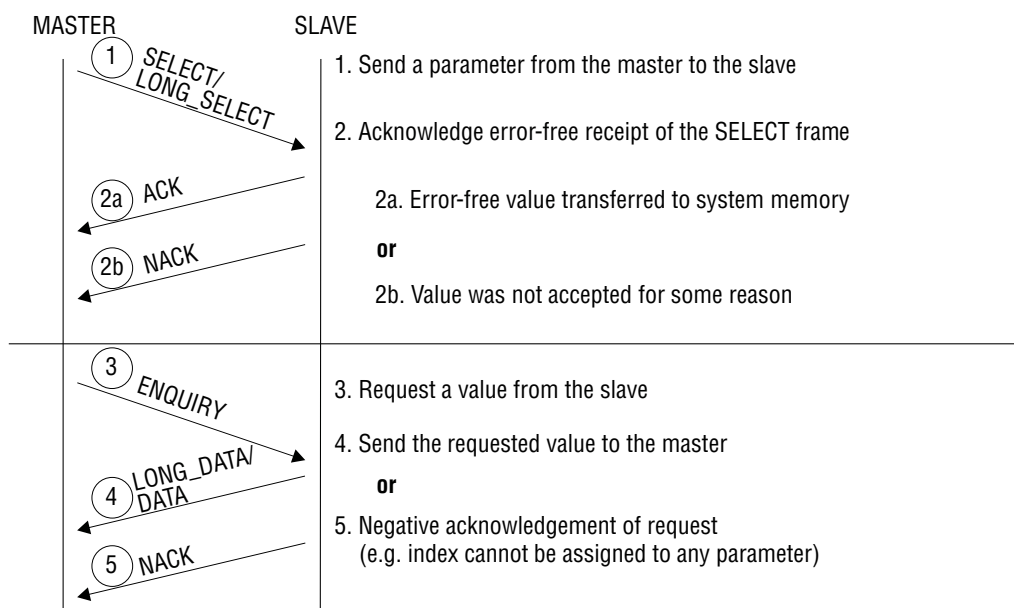

00695AEN

Figure 2: The various message types in the protocol

Figure 2 shows the execution principles of the communications protocol for the serial interfaces of the inverter. Seven different message types (frames) are used which are recognized by their start delimiters (SD):

Type of message	SD	Data service
ENQUIRY	B5 _{hex}	Request parameter value
DATA	C8 _{hex}	Acknowledgement with parameter value
LONG_DATA	AC _{hex}	Acknowledgement with “long” parameter value (8 bytes)
SELECT	A9 _{hex}	Write parameter value
LONG_SELECT	AD _{hex}	Write “long” parameter value (8 bytes)
ACK (ACKNOWLEDGE)	D2 _{hex}	Acknowledgement “understood”
NACK (NOT ACKNOWLEDGE)	F3 _{hex}	Acknowledgement “not understood”

An individual parameter is addressed using the index assigned to it. This assignment is dealt with in the Parameter List (→ Sec. 4).

The message types are described in detail below.

2.1.1.1 ENQUIRY frame

The higher-level control system sends this frame to the inverter **to read the value of the parameter** which is encoded in the index. Following error-free receipt the inverter responds with a DATA or LONG_DATA frame. In the case of an error, it returns a NACK frame with the appropriate return code.

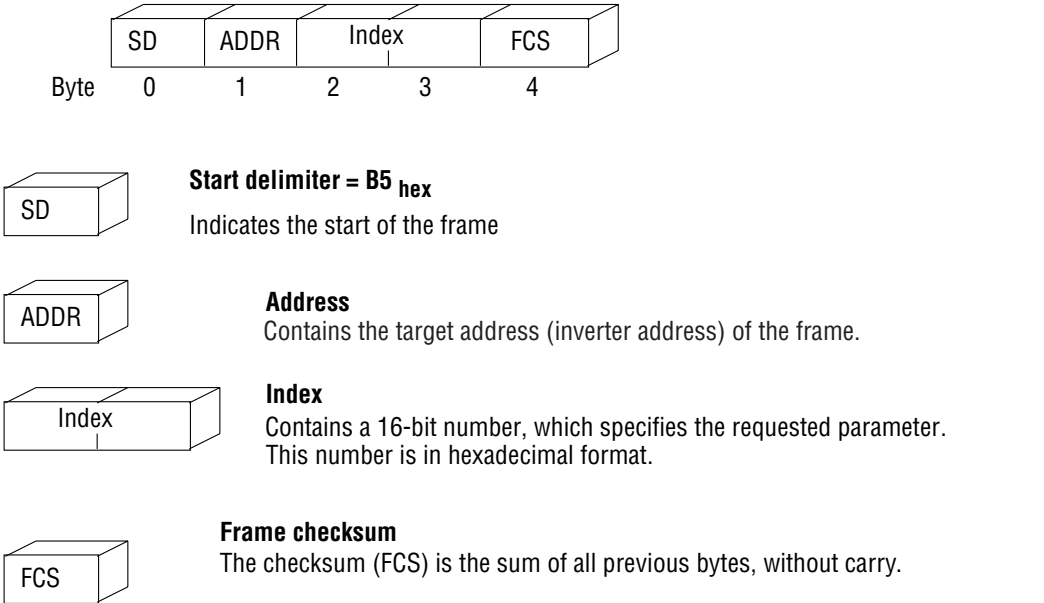
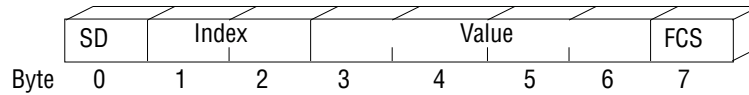

Figure 3: ENQUIRY frame

2.1.1.2 DATA frame

The MOVITRAC[®] 31.. uses this frame **to send the requested data** in response to an ENQUIRY frame of the higher-level control system.



Start delimiter = C8_{hex}
Indicates the start of the frame

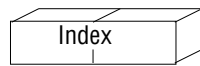

Index
Contains a 16-bit number, which specifies the requested parameter.
This number is in hexadecimal format.

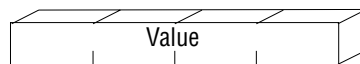

Value
Contains the value of a parameter.



Frame checksum
The checksum (FCS) is the sum of all previous bytes, without carry.

00712AEN

Figure 4: DATA frame

2.1.1.3 LONG_DATA frame

The MOVITRAC[®] 31.. uses this frame **to send the requested data in 8-byte format** in response to an ENQUIRY frame of the higher-level control system.

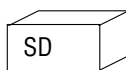
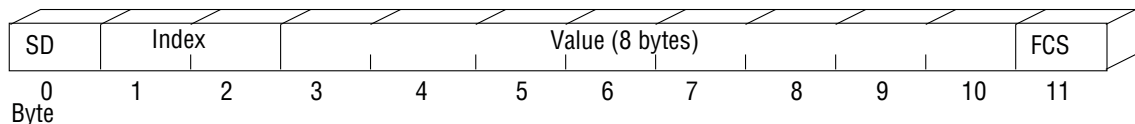

Start delimiter = AC_{hex}
Indicates the start of the frame.

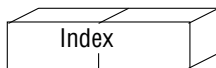

Index
Contains a 16-bit number, which specifies the requested parameter.
This number is in hexadecimal format.

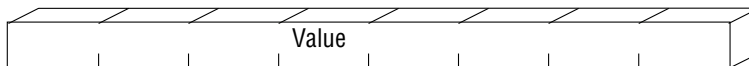

Value
Contains the value of a parameter.



Frame checksum
The checksum (FCS) is the sum of all previous bytes, without carry.

00713AEN

Figure 5: LONG_DATA frame

2.1.1.4 SELECT frame

The higher-level control system sends this frame to the inverter to **overwrite a parameter in the unit**. After successful receipt, the MOVITRAC[®]31.. responds with an ACK frame or, in the case of an error, with a NACK frame.

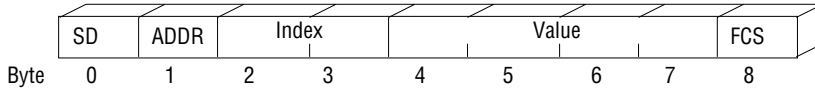

Start delimiter = A9 hex
Indicates the start of the frame.

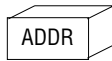

Address
Contains the target address (inverter address) of the frame.

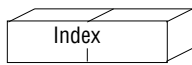

Index
Contains a 16-bit number, which specifies the requested parameter. This number is in hexadecimal format.

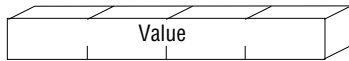

Value
Contains the value of a parameter.



Frame checksum
The checksum (FCS) is the sum of all previous bytes, without carry.

00714AEN

Figure 6: SELECT frame

2.1.1.5 LONG_SELECT frame

The higher-level control system sends this frame to the inverter to **overwrite an 8-byte parameter in the unit**. After successful receipt, the MOVITRAC[®]31.. responds with an ACK frame or, in the case of an error, with a NACK frame.

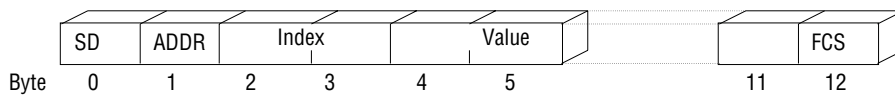

Start delimiter = AD hex
Indicates the start of the frame.



Address
Contains the target address (inverter address) of the frame.

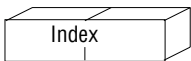

Index
Contains a 16-bit number, which specifies the requested parameter. This number is in hexadecimal format.

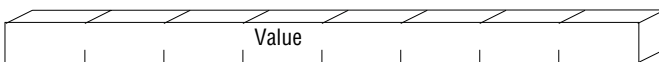

Value
Contains the value of a parameter.

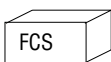

Frame checksum
The checksum (FCS) is the sum of all previous bytes, without carry.

00715AEN

Figure 7: LONG_SELECT frame



2.1.1.6 ACK (Acknowledge) frame

The inverter uses this frame to **acknowledge error-free receipt** of the SELECT frame.

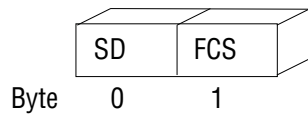

Start delimiter = D2_{hex}
Indicates the start of the frame.



Frame checksum
The checksum (FCS) is the sum of all previous bytes, without carry.

00716AEN

Figure 8: ACK frame

2.1.1.7 NACK (Not Acknowledge) frame

This frame is used by the inverter following receipt of an ENQUIRY, SELECT or LONG_SELECT frame to inform the higher-level control system that the **requested service could not be carried out**.

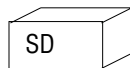
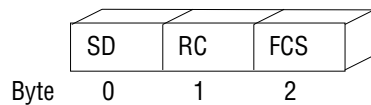

Start delimiter = F3_{hex}
Indicates the start of the frame.

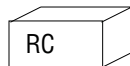

Return Code
Indicates the cause of the fault in coded form (→ Sec. 2.1.2).



Frame checksum
The checksum (FCS) is the sum of all previous bytes, without carry.

00717AEN

Figure 9: NACK frame

2.1.2 Return codes (RC)

The table below lists the possible return codes (RC) in a NACK frame:

RC _{hex}	Meaning
10	Illegal index
11	Function/parameter not implemented
12	Read access only
13	Parameter lock (P 800) active
14	Factory setting (P 830) running
15	Parameter value too large
16	Parameter value too small
17	Necessary option pcb for function or parameter not installed
18	Fault in system software
19	Parameter access via this serial interface not permitted
1A	Speed control (P 770) active
1B	Unauthorized access
1C	Output stage is not inhibited
1D	Invalid parameter value (e.g. invalid intermediate value)
1E	Factory setting was started
22	4Q operation 1 (P 890) required, e.g. for hoist function 1 (P 710)
23	4Q operation 2 (P 891) required, e.g. for hoist function 2 (P 712)
24	DC braking 1 (P 730) active; no change possible
25	DC braking 2 (P 733) active; no change possible
26	Hoist function set 1 (P 710) active; no change possible
27	Hoist function set 2 (P 712) active; no change possible
28	Parameter stored to volatile memory, lost on power-down
29	Parameter access via this serial interface not permitted
2A	Speed control (P 770) inactive
2B	Controller inhibit required
2C	Motor size-up 1 (P 328) and rapid start 1 (P 720) cannot be activated at the same time
2D	Motor size-up 2 (P 348) and rapid start 2 (P 723) cannot be activated at the same time
2E	Necessary option pcb for function or parameter not installed
2F	4Q operation 1 (P 890) and DC braking 1 (P 730) cannot be activated at the same time
30	4Q operation 2 (P 891) and DC braking 2 (P 733) cannot be activated at the same time
31	Controller inhibit active; no change possible
32	Synchronous operation control (P 760) inactive
33	Synchronous operation control: MOVITRAC is slave (P 761)
34	Illegal message type

2.1.3 Application examples

The following examples illustrate the execution sequence of the protocol and the use of the associated frames. All figures are in hexadecimal format.

2.1.3.1 Reading the parameter “Heat sink temperature” (P 001)

The application program installed on a PLC is required to evaluate the heat sink temperature of the inverter with the address 12 for safety purposes. This address has previously been set with the control keypad.

The PLC (master) sends an ENQUIRY frame with the following format:

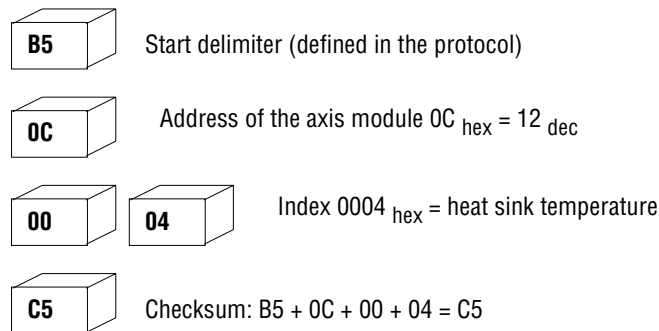
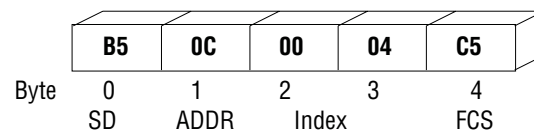

00718AEN

Figure 10: Sending the ENQUIRY frame

After error-free receipt of the ENQUIRY frame the MOVITRAC[®] replies with a DATA frame containing the value for the heat sink temperature (25.5°C).

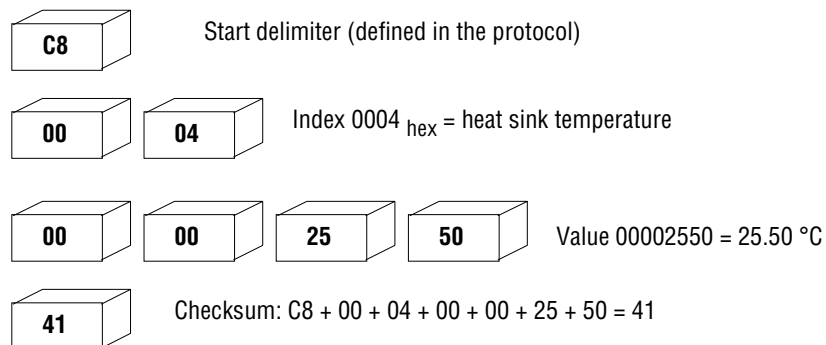
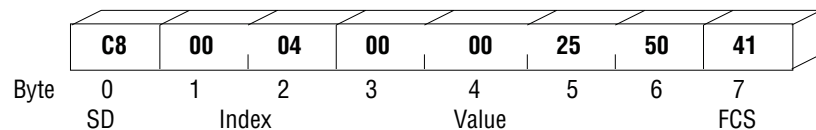

00719AEN

Figure 11: Replying with a DATA frame

2.1.3.2 Writing the parameter “T11 RAMP UP” (P 120)

The PLC (master) is required to set the time for the first acceleration ramp (T11) to a value of 3.7 seconds. The following SELECT frame must be sent to the inverter for this purpose:

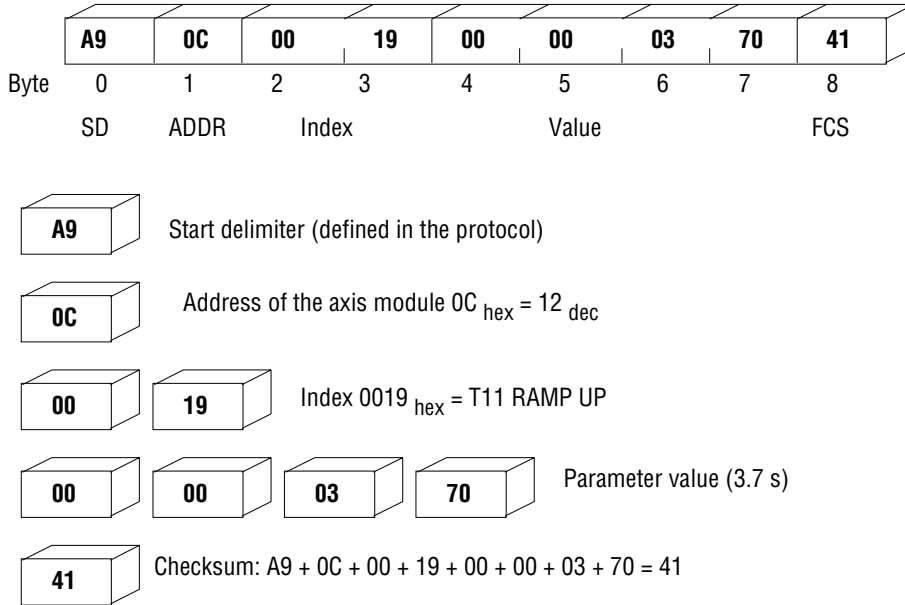

00720AEN

Figure 12: Sending the SELECT frame

The inverter acknowledges error-free transfer of the value to the parameter memory with an ACK frame.

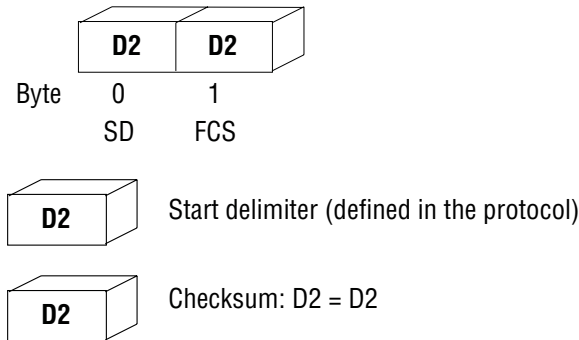

00721AEN

Figure 13: Replying with an ACK frame

2.2 The RS-232 interface

2.2.1 Connecting the MOVITRAC[®] 31.. to a PC

The RS-232 serial connection between a MOVITRAC[®] 31.. and a PC (or a higher-level control system) is made with the USS 11A interface option, which is plugged into the X4 connector on the front of the unit. The interface has a 9-pin type D socket of which only 3 connections (pins 2, 3, 5) are used. The other pins are not connected. Figure 14 shows a schematic of the connector pinout.

The units are connected with a commercial RS-232 cable (9-pin type D connector to 9-pin type D connector). Connections 2 and 3 are the data lines. Pin 5 is the ground connection for the units.

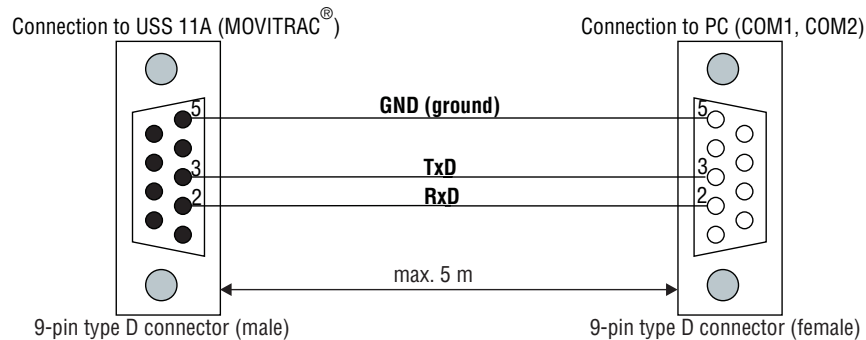

00722AEN

Figure 14: Interface cable between the MOVITRAC[®] 31.. and the PC

Figure 15 shows the physical signal levels of the interface lines TxD (transmit data) and RxD (receive data).

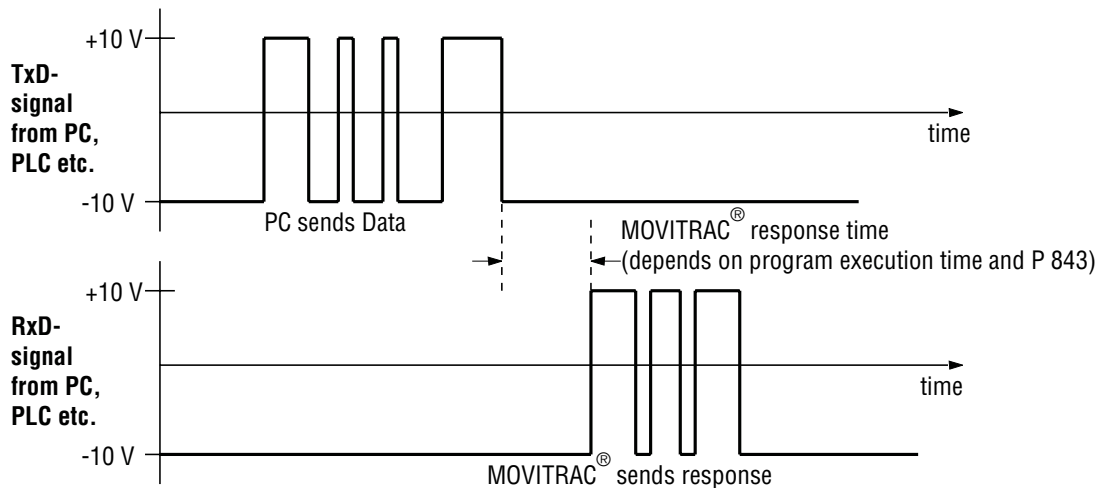

00723AEN

Figure 15: Signal levels of the interface leads

SEW-EURODRIVE provides a powerful tool in the form of the MC_SHELL PC program, which is specially designed for parameter setting of MOVITRAC[®] frequency inverters via PC.

A communications processor which provides the functionality of an RS-232 interface is required for the connection to a PLC. SIEMENS, for example, offers the CP 523 serial communications module for the SIMATIC[®] S5.

2.2.2 Technical data of the MOVITRAC[®] RS-232 interface

- Standard DIN 66020 (V.24) and RS-232
- Baud rate 9600 baud
- Start bits 1 start bit
- Stop bits 1 stop bit
- Data bits 8 data bits
- Parity none
- Data direction bidirectional
- Operating mode asynchronous, half-duplex
- Max. cable length 5 m or 16.5 ft
- Number of stations 1 master (PC/higher-level control system) + slave (MOVITRAC[®])

SIMATIC[®] is a registered trademark of SIEMENS AG



2.3 The RS-485 interface

The RS-485 interface is available on terminals 67/68 of the UST 11A option (plugs into X4) and on the FEA 31.. and FIO 31.. options (plugs into X20).

These interfaces have two principal functions:

1. Networking of an automation unit with several inverters.
2. Master-slave operation with 2 or more MOVITRAC[®] 31 units.
Only available in combination with the FEA 31/FIO 31, not the UST 11A.

Note:

The terminating resistor is already provided on the FEA 31.., FIO 31.. and UST 11A options and must not be connected externally.

2.3.1 Networking the MOVITRAC[®] 31..

Simultaneous acquisition or alteration of the process states or the parameter setting of several inverters from an automation unit requires internetworking these units with the possibility of addressing each of them individually.

The unit addresses for the individual MOVITRAC[®] 31.. inverters must be set separately by using the menu in the FBG 31 control keypad before commissioning the network. It must be ensured that each unit has unique address assigned to it from the 64 possible addresses. If two or more units have the same address then bus conflicts and resulting data loss are unavoidable.

The physical characteristics of the RS-485 interface only permit single-master operation, i.e. only one station in the network can have permission to send, i.e. be the master, at any particular time.

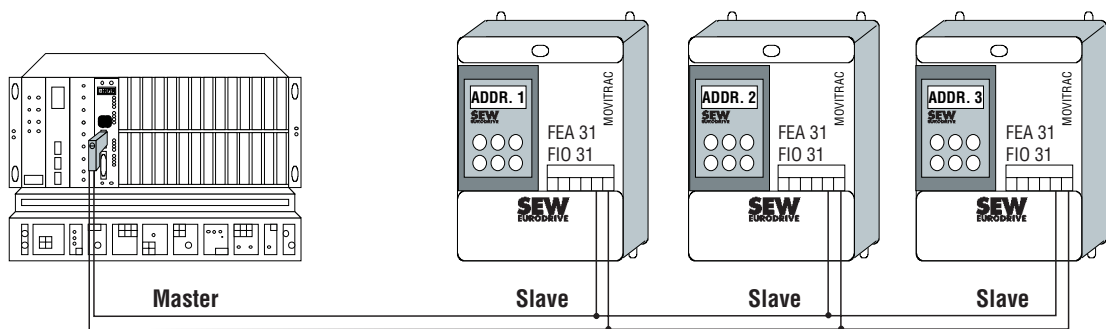

00724AEN

Figure 16: Networking the MOVITRAC[®] 31..

2.3.2 Master-slave operation

An additional protocol has been implemented which offers the user the possibility of master-slave operation of several inverters via an RS-485 network. To achieve this the inverters are connected in parallel, as shown in Figure 17 below. The appropriate settings are then made in the menu to determine which inverter takes over the role of master (setpoint source). All other units work as slaves.

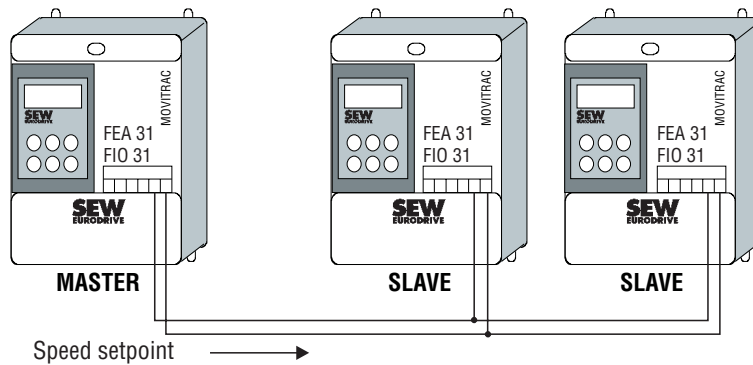

00725AEN

Figure 17: Master-slave operation via RS-485

The setpoint given by the master can be scaled with a factor between 0.1 and 10.0 and thus individually adapted for each slave. After master-slave operation has been activated on all the inverters, the master starts to send out the setpoint cyclically. The setpoint is transmitted simultaneously and without acknowledgement to all slaves. This means that the master does not have any information about which slaves have actually received the setpoint without any errors, and which have not. If an inverter is selected as a slave, then all other internal and external setpoint references become ineffective.

The setpoint which is provided by the master can have various origins:

- a setpoint which is specified to the master via a fieldbus
- an external or internal setpoint
- a setpoint from the RS-232 interface (USS 11A)

Notes:

1. In order to guarantee secure data transmission, it is necessary to ensure that only one inverter in the network takes over the master function.
2. Communication between a PC and an inverter via the RS-485 interface (UST 11A, FEA 31, FIO 31) is not possible when master-slave operation is activated. The PC must be disconnected from the master-slave network!
3. The address which is set has no effect in this mode of operation. The setpoint goes to all the slave units.

2.3.3 Technical data of the MOVITRAC® RS-485 interface

- Standard RS-485
- Baud rate 9600 baud
- Start bits 1 start bit
- Stop bits 1 stop bit
- Data bits 8 data bits
- Parity none
- Data flow bidirectional
- Operating mode half-duplex, asynchronous
- Terminating resistor already fitted
- Max. cable length 200 m or 660 ft between 2 stations
- Number of stations 1 master + max. 31 slaves



2.4 Communicating with a PLC

For a PLC and a MOVITRAC[®] 31.. unit to communicate, fit the PLC with a communications module (communications processor, CP) which allows the transmission protocol to be freely programmed. In the case of the SIMATIC[®] S5, for example, you may use the CP523 module to link the MOVITRAC[®] 31.. frequency inverter to the PLC via the RS-232 interface. This communications module supports the communications mode “transparent”, i.e. the protocol to be transmitted can be freely programmed by the user.

Transfer of parameter settings see the Siemens CP523 communications module manual.

2.4.1 System requirements

To establish a communications link between a SIMATIC[®] S5 and the MOVITRAC[®] 31.. frequency inverter using the RS-232 serial interface you will need the following hardware components:

- 1 MOVITRAC[®] 31..
- 1 USS 11A
- 1 communications module CP523 for the S5-series
- 1 interface cable (see Figure 18)

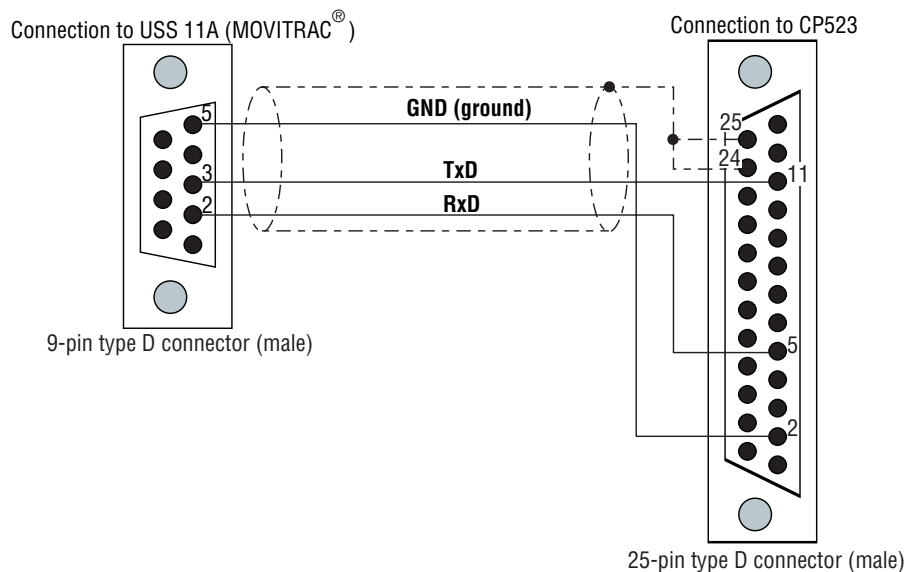

00726AEN

Figure 18: Interface cable between a MOVITRAC[®] 31.. and a CP523

2.4.2 Initializing the PLC module CP523 in the user program

In the communications mode the CP523 communications processor allows up to 256 bytes to be transmitted with a CPU request. In the communications mode “transparent” the CP523 does not interpret any characters. All data transmitted with a send request are therefore directly output on the interface. At the same time the CP523 stores all data received directly in the receive buffer allowing the received data to be picked up with the appropriate CPU request.

As the length of the frames used for communication with the MOVITRAC[®] 31.. frequency inverter varies, the maximum frame length must be set to accommodate the longest possible frame (LONG_SELECT frame = 13 bytes).

To initialize the communications interface, a parameter block is transmitted to the CP523. You may use the CPU request “Transfer parameter data” to do this. The following tables show the settings for these parameter blocks which are used to initialize communication with the MOVITRAC[®] 31 frequency inverter.

Transfer buffer assignment for parameter block 0:

Byte	Meaning	Value for MOVITRAC [®] 31..
0	Request no. “Transfer parameter data”	90 hex
1	Parameter block no.	00 hex
2	Baud rate: 9600 baud	08 hex
3	Parity check: No check	04 hex
4	Busy signal: NO	00 hex
5	Interface: V.24	01 hex
6	Data format: 10 bits, 1 start bit + 8 data bits + 1 stop bit	05 hex
7	Hardware handshake. OFF	00 hex

Transfer buffer assignment for parameter block 7:

Byte	Meaning	Value for MOVITRAC [®] 31..
0	Request no. “Transfer parameter data”	90 hex
1	Parameter block 7, communications mode “transparent”	71 hex
2 + 3	Character delay time: 10 ms	0001 hex
4 + 5	Max. frame length: 13 bytes	000D hex
6 + 7	No function	0000 hex

2.4.3 Example: Reading the parameter “Heat sink temperature” (P 001)

To read out the heat sink temperature of a frequency inverter with the address 0, the CP523 is to send an ENQUIRY frame to the inverter. The transfer buffer and the transfer procedure are as follows:

1. CP523 initialization: “Send frame” (A001_{hex}) with a data length = 5 bytes (since the ENQUIRY frame is 5 bytes long).
2. Transfer of the send data in the transfer buffer to the CP523.

Transferring the ENQUIRY frame to the CP523:

Byte	Meaning	Value for MOVITRAC® 31..
0	Start delimiter SD	B5 _{hex}
1	Address: 0	00 _{hex}
2 + 3	Index of the parameter “heat sink temperature”	0004 _{hex}
4	Checksum = B5 + 00 + 00 + 04 = B9	00B9 _{hex}
5 - 7	No function	00 _{hex}

3. The CP523 automatically sends the ENQUIRY frame to the inverter.
4. The CP523 automatically receives the DATA frame from the inverter and stores it in the receive buffer.
5. The contents of the receive buffer are transferred to the user program with the CPU request “Receive frame” (A080_{hex}). The transfer buffer now contains the DATA frame.

Contents of the transfer buffer after receiving the DATA frame:

Byte	Meaning	Value for MOVITRAC® 31..
0	Start delimiter SD	C8 _{hex}
1 + 2	Index of the parameter “heat sink temperature”	0004 _{hex}
3 + 4	More significant part of the parameter value	e.g. 0000 _{hex}
5 + 6	Less significant part of the parameter value	e.g. 2550 _{hex}
7	Checksum = C8 + 00 + 04 + 00 + 00 + 25 + 50 = 41	41 _{hex}

6. The checksum in byte 7 of the receive buffer is then evaluated. If the recalculated checksum corresponds to the checksum in byte 7, the frame was received correctly. If not, the read process must be repeated.

In the above example a heat sink temperature of 25.5°C was read out.

2.4.4 Example: Writing the parameter “T11 RAMP UP” (P 120)

To set the parameter “T11 RAMP UP” of a frequency inverter with the address 0 to 3.7s, the CP523 is to send a SELECT frame to the inverter. The transfer buffer and the transfer procedure are as follows:

1. CP523 initialization: “Send frame” (A001 hex) with a data length = 9 bytes (since the SELECT frame is 9 bytes long).
2. Since the SELECT frame is 9 bytes long, two transfer buffers must be transferred, one after the other, to the CP523. The first transfer buffer contains byte 0 to byte 7 of the SELECT frame, while the second transfer buffer contains only the checksum.

1st transfer buffer of the SELECT frame:

Byte	Meaning	Value for MOVITRAC® 31..
0	Start delimiter SD	A9 hex
1	Address (of no significance for RS-232)	00 hex
2 + 3	Index of the parameter “T11 RAMP UP”	0019 hex
4 + 5	More significant part of the parameter value	0000 hex
6 + 7	Less significant part of the parameter value	0370 hex

2nd transfer buffer of the SELECT frame:

Byte	Meaning	Value for MOVITRAC® 31..
0	Checksum = A9 + 00 + 00 + 19 + 00 + 00 + 03 + 70 = 35	35 hex
1 - 7	No function	00 hex

3. After transfer of all 9 bytes the CP523 automatically sends the SELECT frame to the inverter.
4. The CP523 automatically receives the ACK frame (or in the event of an error the NACK frame) from the inverter and stores it in the receive buffer.
5. The contents of the receive buffer are transferred to the user program with the CPU request “Receive frame” (A080 hex). The transfer buffer now contains the ACK frame.

Contents of the transfer buffer after receiving the DATA frame:

Byte	Meaning	Value for MOVITRAC® 31..
0	Start delimiter SD	D2 hex
1	Checksum: D2	D2 hex

6. The checksum in byte 1 of the receive buffer is then evaluated. If the recalculated checksum corresponds to the checksum in byte 1 (ACK: SD = FCS = D2 hex), the frame was received correctly. If not, the write process must be repeated.

3 Data Formats

The transmission of the parameter values via the serial interfaces is made in a numerical format. Three different formats are used. All “text strings”, such as YES, NO, ON, OFF etc. are given numerical values, which are specified in the following list for each parameter.

3.1 4-byte BCD format

In this format each value takes up four bytes of a frame. The representation is made in BCD (binary-coded decimal) format. This format is identical for the communications interfaces (RS-232 and RS-485) and the fieldbus interfaces.

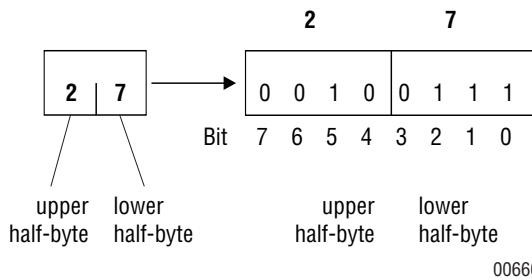

In BCD format the four bits of a byte represent a number from 0 to 9. This means that a byte can be used to represent a value between 00 and 99. Figure 19 shows the value “27” in BCD format in one byte.

00660AEN

Figure 19: BCD format

Each byte has a fixed meaning assigned to it within the 4-byte BCD representation of the parameter values:

Example 1:

The following example shows the 4-byte BCD representation of P 111 “Setpoint offset”, which is to have a value of -237.0mV.

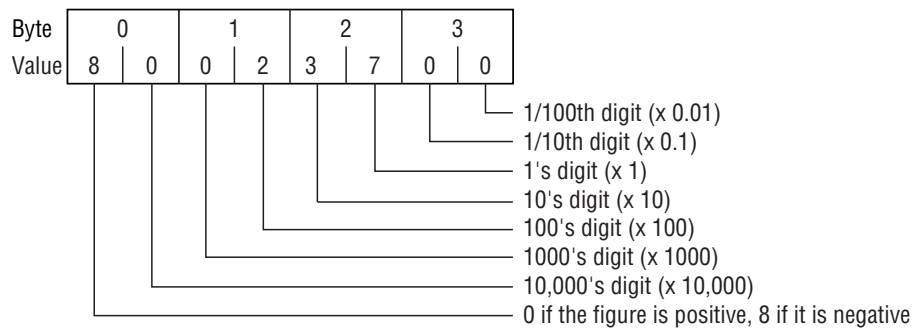

00661AEN

Figure 20: 4-byte BCD format

Example 2:

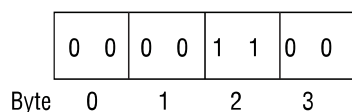

3.2 4-byte binary format

In this format the individual bits or bytes have characteristics or functions assigned to them. Parameters in this format are transmitted uncoded. For these parameters the exact assignment of the data bytes is given in the parameter list. This format is identical for the communications interfaces (RS-232 and RS-485) and the fieldbus interfaces.

Example:

Figure 22 shows the 4-byte binary format representation of index 281_{dec}, "MC 31.. functional bits".

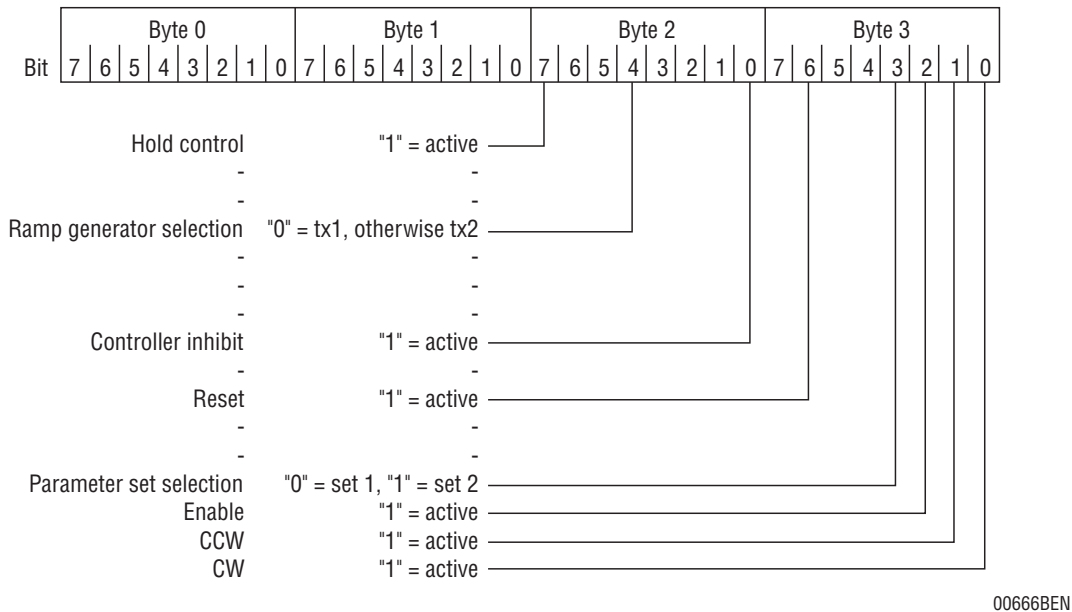

Figure 22: 4-byte binary format

3.3 8-byte format

This format is used to transmit parameters with a 32-bit coded value range. A LONG_SELECT or a LONG-DATA frame are used as means of transmission. This format is used by the synchronous operation control and IPOS parameters. It only applies to the communications interfaces (RS-232 and RS-485), not to the fieldbus interfaces. The format for the fieldbus interfaces is described in the "Fieldbus unit profile" documentation, part no. 0922 7008.

The original value (32 bit) is split up into half-bytes and each half-byte is then transmitted in one frame byte with leading zero.

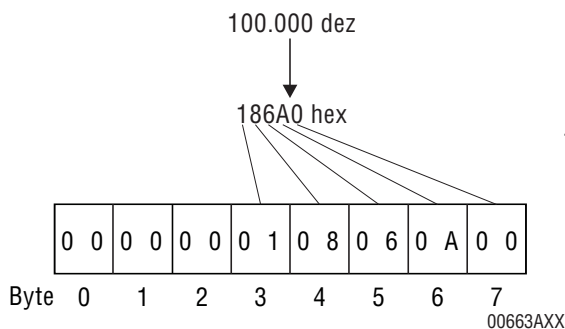

Figure 23: 8-byte format

Example:

Figure 23 shows how P 762 "Master gear ratio" is transmitted. The setpoint has the value 100,000_{dec}.

4 Parameter List

R = READ / W = WRITE

Par. No.	Parameter	Index-No.		Format	Access	Meaning/ Value range																																																						
		dec	hex																																																									
DISPLAY VALUES																																																												
000	Frequency [Hz]	0	0	4-byte BCD	R / -	0...400																																																						
001	Heat sink temperature [°C]	4	4		R / -	-20...+100																																																						
003	External current limit [%]	18	12		R / -	0...100																																																						
004	Speed [1/min]	17	11		R / -	0...9999																																																						
010	DC link voltage [V]	2	2		R / -	0...1000																																																						
011	Motor voltage [V]	1	1		R / -	0...1000																																																						
020	Apparent current [%]	5	5		R / -	0...200																																																						
021	Inverter utilization [%]	6	6		R / -	0...125																																																						
022	Motor utilization 1 [%]	308	134		R / -	0...200																																																						
023	Motor utilization 2 [%]	309	135		R / -	0...200																																																						
030	Status binary inputs 41-47	13	D	4-byte binary	R / -	<table border="0"> <tr> <td rowspan="7">Byte 3</td> <td>0</td> <td>TL. 41</td> <td rowspan="7">Par. No. 30</td> </tr> <tr><td>1</td><td>TL. 42</td></tr> <tr><td>2</td><td>TL. 43</td></tr> <tr><td>3</td><td>TL. 47</td></tr> <tr><td>4</td><td>TL. 48</td></tr> <tr><td>5</td><td>TL. 49</td></tr> <tr><td>6</td><td>TL. 50</td></tr> <tr> <td rowspan="7">Byte 2</td> <td>7</td> <td>TL. 51</td> <td rowspan="7">Par. No. 31</td> </tr> <tr><td>0</td><td>TL. 61</td></tr> <tr><td>1</td><td>TL. 62</td></tr> <tr><td>2</td><td>TL. 63</td></tr> <tr><td>3</td><td>TL. 64</td></tr> <tr><td>4</td><td>TL. 69</td></tr> <tr><td>5</td><td>TL. 70</td></tr> <tr> <td rowspan="7">Byte 1</td> <td>6</td> <td>TL. 71</td> <td rowspan="7">Par. No. 43</td> </tr> <tr><td>7</td><td>TL. 72</td></tr> <tr><td>0</td><td>TL. 52</td></tr> <tr><td>1</td><td>TL. 53</td></tr> <tr><td>2</td><td>TL. 54</td></tr> <tr><td>3</td><td>-</td></tr> <tr><td>4</td><td>-</td></tr> <tr><td>5</td><td>-</td></tr> <tr><td>6</td><td>-</td></tr> <tr><td>7</td><td>-</td></tr> </table> <p>Byte 0: No function</p>	Byte 3	0	TL. 41	Par. No. 30	1	TL. 42	2	TL. 43	3	TL. 47	4	TL. 48	5	TL. 49	6	TL. 50	Byte 2	7	TL. 51	Par. No. 31	0	TL. 61	1	TL. 62	2	TL. 63	3	TL. 64	4	TL. 69	5	TL. 70	Byte 1	6	TL. 71	Par. No. 43	7	TL. 72	0	TL. 52	1	TL. 53	2	TL. 54	3	-	4	-	5	-	6	-	7	-
Byte 3	0	TL. 41	Par. No. 30																																																									
	1	TL. 42																																																										
	2	TL. 43																																																										
	3	TL. 47																																																										
	4	TL. 48																																																										
	5	TL. 49																																																										
	6	TL. 50																																																										
Byte 2	7	TL. 51	Par. No. 31																																																									
	0	TL. 61																																																										
	1	TL. 62																																																										
	2	TL. 63																																																										
	3	TL. 64																																																										
	4	TL. 69																																																										
	5	TL. 70																																																										
Byte 1	6	TL. 71	Par. No. 43																																																									
	7	TL. 72																																																										
	0	TL. 52																																																										
	1	TL. 53																																																										
	2	TL. 54																																																										
	3	-																																																										
	4	-																																																										
5	-																																																											
6	-																																																											
7	-																																																											
031	Status binary inputs 48-51	13	D	R / -																																																								
032	Status binary inputs 52-54	13	D	R / -																																																								
040	Status binary outputs 61-64	13	D	R / -																																																								
043	Status binary outputs 69-72	13	D	R / -																																																								
050	Option at X20	237	ED	4-byte binary	R / -	Byte 3: No function																																																						
051	Option at X21	237	ED		R / -	<table border="0"> <tr> <td rowspan="7">Byte 2</td> <td>0</td> <td rowspan="7">Option at X21: Bit combination in BCD format</td> <td rowspan="7">0 = Short circuit 1 = FEN 2 = Binary inputs 3 = FPI 9 = None</td> </tr> <tr><td>1</td></tr> <tr><td>2</td></tr> <tr><td>3</td></tr> <tr><td>4</td></tr> <tr><td>5</td></tr> <tr><td>6</td></tr> <tr> <td rowspan="7">Byte 1</td> <td>7</td> <td rowspan="7">Option at X20: Bit combination in BCD format</td> <td rowspan="7">0 = Short circuit 1 = FEA 2 = FF. (Fieldbus) 3 = FME 4 = FES 5 = FIO 9 = None</td> </tr> <tr><td>0</td></tr> <tr><td>1</td></tr> <tr><td>2</td></tr> <tr><td>3</td></tr> <tr><td>4</td></tr> <tr><td>5</td></tr> <tr><td>6</td></tr> <tr><td>7</td></tr> </table> <p>Byte 0: No function</p>	Byte 2	0	Option at X21: Bit combination in BCD format	0 = Short circuit 1 = FEN 2 = Binary inputs 3 = FPI 9 = None	1	2	3	4	5	6	Byte 1	7	Option at X20: Bit combination in BCD format	0 = Short circuit 1 = FEA 2 = FF. (Fieldbus) 3 = FME 4 = FES 5 = FIO 9 = None	0	1	2	3	4	5	6	7																																
Byte 2	0	Option at X21: Bit combination in BCD format	0 = Short circuit 1 = FEN 2 = Binary inputs 3 = FPI 9 = None																																																									
	1																																																											
	2																																																											
	3																																																											
	4																																																											
	5																																																											
	6																																																											
Byte 1	7	Option at X20: Bit combination in BCD format	0 = Short circuit 1 = FEA 2 = FF. (Fieldbus) 3 = FME 4 = FES 5 = FIO 9 = None																																																									
	0																																																											
	1																																																											
	2																																																											
	3																																																											
	4																																																											
	5																																																											
6																																																												
7																																																												

00732AEN

00733AEN

Par. No.	Parameter	Index-No.		Format	Access	Meaning/ Value range	
		dec	hex				
060	Fault t-0	8	8	4-byte BCD	R / -	0 = No fault	1 = Overcurrent
061	Fault t-1	9	9		R / -	2 = DC-link voltage	3 = Brake chopper
062	Fault t-2	10	A		R / -	4 = Continuous overload	5 = Regenerative Overld.
063	Fault t-3	11	B		R / -	6 = Overheating	7 = Phase failure
064	Fault t-4	12	C		R / -	8 = No function	9 = No function
						10 = Direction of rotation	11 = Speed detection
						12 = Motor overload	13 = Start conditions
						14 = Output open circuit	15 = No function
						16 = No function	17 = Stack overflow
						18 = Stack underflow	19 = Non-maskable interrupt
						20 = Undef. op. code	21 = Protected instruction
						22 = Illegal op. access	23 = Illegal instruct. access
						24 = Illegal bus access	25 = EEPROM fault
						26 = Keypad connection	27 = Ext. terminal
						28 = Fieldbus time out	29 = No function
						30 = No function	31 = No function
						32 = No function	33 = Master-slave connection
						34 = Fieldbus time out	35 = No function
						36 = FRS Master-slave connection	
						37 = FRS RAM fault	38 = FRS process data error
						39 = FRS parameter data error	
						40 = No function	41 = FRS lag error
						42 = No function	43 = Bin. output short-circuit
						44 = Static RAM fault	45 = PC time out
						46 = No function	47 = No function
						48 = No function	49 = No function
						50 = Limit switch missing	51 = Zero pulse time out
						52 = Limit switches reversed	53 = No function
						54 = Motor overload	55 = Invalid IPOS command
						56 = Watchdog-timer error	57 = Teach error
						58 = Invalid control word	59 = Software limit switch
						60 = Lag error	61 = Ref. travel fault
						62 = Index overflow	63 = Undef. jump destination
						64 = CW limit switch active	65 = CCW limit switch active
						66-86 = No function	87 = Fieldbus time out
070	Process data configuration	600	258		R / -	0.00 = 1PD+parameter	1.00 = 1PD
						2.00 = 2PD+parameter	3.00 = 2PD
						4.00 = 3PD+parameter	5.00 = 3PD
071	Fieldbus type	610	262		R / -	0.00 = None	1.00 = PROFIBUS
						2.00 = INTERBUS-S	3.00 = BECKHOFF IIO
						4.00 = CAN	
072	Fieldbus baud rate [kB]	611	263		R / -	0...1500	
073	Fieldbus address	612	264		R / -	0...255	
074	PO1 Setpoint (hex)	613	265		R / -	0000...FFFF	
075	PI1 Actual value (hex)	616	268		R / -		
076	PO2 Setpoint (hex)	614	266		R / -		
077	PI2 Actual value (hex)	617	269		R / -		
078	PO3 Setpoint (hex)	615	267		R / -		
079	PI Actual value (hex)	618	26A		R / -		

Par. No.	Parameter	Index-No.		Format	Access	Meaning/ Value range
		dec	hex			
SETPOINTS / RAMP GENERATORS						
100	n1 characteristic	21	15	4-byte BCD	R / W	0.00 = Gain 1.00 = Offset
101	n1 gain factor	22	16		R / W	0.10...10.00 Step 0.10
102	n1 offset factor	23	17		R / W	0.10...10.00 Step 0.10
110	n2 signal TL. 34/35	24	18		R / W	0.00 = 0...10V or 0...20mA 1.00 = -10...+10V or 4...20mA (depends on S1)
111	Setpoint offset n2 [mV]	98	62		R / W	-500...0...+500mV Step 10mV
120	t11 ramp UP [s]	25	19		R / W	0.00...10.00 Step 0.05 10.00...100.00 Step 0.5 100.00...1000.00 Step 5 1000.00...2000.00 Step 10
121	t11 ramp DOWN [s]	26	1A		R / W	→ No.120
122	t11 S pattern	29	1D		R / W	0.00...3.00 Step 1.00
123	t21 ramp UP [s]	230	E6		R / W	→ No.120
124	t21 ramp DOWN [s]	231	E7		R / W	→ No.120
125	t21 S pattern	234	EA		R / W	0.00...3.00 Step 1.00
130	t12 ramp UP=DOWN [s]	27	1B		R / W	→ No.120
131	t22 ramp UP=DOWN [s]	232	E8		R / W	→ No.120
140	t13 ramp STOP [s]	28	1C		R / W	0.00...9.95 Step 0.05
141	t23 ramp STOP [s]	233	E9		R / W	→ No.140
150	Motorized potentiometer	30	1E		R / W	0.00 = No 1.00 = Yes
151	t4 ramp UP [s]	31	1F		R / W	1.00...60.00 Step 1.00
152	t4 ramp DOWN [s]	32	20		R / W	→ No.151
153	Save last position	33	21	R / W	0.00 = No 1.00 = Yes	
154	Motor. pot. + ext. setpoint	34	22	R / W	0.00 = No 1.00 = Yes	
160	n11 [Hz]	35	23	R / W	0.00...400.00 Step 0.05	
161	n12 [Hz]	36	24	R / W	→ No.160	
162	n13 [Hz]	37	25	R / W	→ No.160	
163	Mix: 1st set + n1	38	26	R / W	0.00 = No 1.00 = Yes	
170	n21 [Hz]	39	27	R / W	→ No.160	
171	n22 [Hz]	40	28	R / W	→ No.160	
172	n23 [Hz]	41	29	R / W	→ No.160	
173	Mix: 2nd set + n1	42	2A	R / W	0.00 = No 1.00 = Yes	
180	Setpoint stop function 1	291	123	R / W	0.00 = No 1.00 = Yes	
181	STOP setpoint 1 [Hz]	292	124	R / W	0.00...25.00 Step 0.05	
182	Start hysteresis 1 [Hz]	293	125	R / W	0.00...5.00 Step 0.05	
183	Setpoint stop function 2	294	126	R / W	0.00 = No 1.00 = Yes	
184	STOP setpoint 2 [Hz]	295	127	R / W	→ No.181	
185	Start hysteresis 2 [Hz]	296	128	R / W	→ No.182	
FREQUENCY CHARACTERISTICS						
200	f _{min} 1 [Hz]	79	4F	4-byte BCD	R / W	0.00...40.00 Step 0.05
201	f _{base} 1 stepped [Hz]	80	50		R / W	0.00=50 / 1.00=60 / 2.00=87 / 3.00=104 / 4.00=120
202	f _{max} 1 [Hz]	81	51		R / W	5.00...150.00 Step 0.05
210	f _{min} 2 [Hz]	82	52		R / W	→ No.200
211	f _{base} 2 stepped [Hz]	83	53		R / W	→ No.201
212	f _{max} 2 [Hz]	84	54		R / W	→ No.202
220	f _{min} 3 [Hz]	85	55		R / W	0.00...150.00 Step 0.05
221	f _{base} stepless [Hz]	86	56		R / W	5.00...400.00 Step 1.00
222	f _{max} 3 [Hz]	87	57		R / W	5.00...400.00 Step 0.05
230	1st frequency window skip	90	5A		R / W	0.00 = No 1.00 = Yes
231	Window centre [Hz]	91	5B		R / W	5.00...150.00 Step 0.05
232	Window width ±[Hz]	92	5C		R / W	2.00...9.00 Step 1.00
250	V/f pattern parameter set 1	88	58		R / W	0.00 = V/f pattern 3 1.00 = V/f pattern 1
251	V/f pattern parameter set 2	89	59		R / W	0.00 = V/f pattern 3 1.00 = V/f pattern 2
260	Set 1 START/STOP freq. [Hz]	96	60		R / W	0.00...10.00 Step 0.05
261	Set 2 START/STOP freq. [Hz]	97	61		R / W	→ No.260

Par. No.	Parameter	Index-No.		Format	Access	Meaning/ Value range	
		dec	hex				
MOTOR PARAMETERS							
310	Motor rated current 1 [%]	310	136	4-byte BCD	R / W	20.00...200.00 Step 1.00	
311	PWM FIX 1	329	149		R / W	0.00 = No 1.00 = Yes	
320	I_{max} 1 [% I_N]	102	66		R / W	20.00...150.00 Step 1.00	
321	Boost 1 [%]	103	67		R / W	0.00...200.00 Step 1.00	
322	$I \times R$ 1 [%]	104	68		R / W	→ No.321	
323	Slip 1 [Hz]	105	69		R / W	0.00...10.00 Step 0.05	
324	Pole pair number 1	106	6A		R / W	1.00...6.00 Step 1.00	
325	PWM frequency 1 [kHz]	272	110		R / W	0.00 = No function 2.00 = 8 4.00 = 16 1.00 = 4 3.00 = 12	
326	Premagnetization time 1 [ms]	277	115		R / W	0.00...300.00 Step 10.00	
327	Postmagnetization time 1 [ms]	278	116		R / W	→ No.326	
328	Motor size-up 1	267	10B		R / W	0.00 = No 1.00 = Yes	
329	Motor voltage 1 [V]	286	11E		R / W	200.00...600.00 Step 1.00	
330	Motor rated current 2 [%]	311	137		R / W	→ No.310	
331	PWM FIX 2	330	14A		R / W	0.00 = No 1.00 = Yes	
340	I_{max} 2 [% I_N]	111	6F		R / W	→ No.320	
341	Boost 2 [%]	112	70		R / W	→ No.321	
342	$I \times R$ 2 [%]	113	71		R / W	→ No.321	
343	Slip 2 [Hz]	114	72		R / W	→ No.323	
344	Pole pair number 2	115	73		R / W	→ No.324	
345	PWM frequency 2 [kHz]	273	111		R / W	→ No.325	
346	Premagnetization time 2 [ms]	279	117		R / W	→ No.326	
347	Postmagnetization time 2 [ms]	280	118		R / W	→ No.326	
348	Motor size-up 2	269	10D		R / W	0.00 = No 1.00 = Yes	
349	Motor voltage 2 [V]	287	11F		R / W	→ No.286	
350	Enable parameter set selection	116	74		R / W	0.00 = No 1.00 = Yes	
REFERENCE VALUES							
400	1st frequency reference [Hz]	117	75		4-byte BCD	R / W	2.00...150.00 Step 1.00
401	1st hysteresis \pm [Hz]	118	76			R / W	1.00...9.00 Step 1.00
402	1st delay [s]	119	77			R / W	0.00...9.00 Step 1.00
403	1st signal = 1 if:	123	7B			R / W	0.00 = $f < f_{ref} 1$ 1.00 = $f > f_{ref} 1$
410	2nd frequency reference [Hz]	120	78			R / W	→ No.400
411	2nd hysteresis \pm [Hz]	121	79			R / W	→ No.401
412	2nd delay [s]	122	7A			R / W	→ No.402
413	2nd signal = 1 if:	124	7C			R / W	0.00 = $f < f_{ref} 2$ 1.00 = $f > f_{ref} 2$
430	Hysteresis \pm [Hz]	126	7E			R / W	→ No.401
431	Signal = 1 if:	127	7F	R / W		0.00 = act. value=setpoint 1.00 = act. value \neq setpoint	
450	1st current ref. value [% I_N]	129	81	R / W		10.00...150.00 Step 1.00	
451	1st hysteresis \pm [% I_N]	130	82	R / W		→ No.401	
452	1st delay [s]	131	83	R / W		→ No.402	
453	1st signal = 1 if:	132	84	R / W		0.00 = $I < I_{ref} 1$ 1.00 = $I > I_{ref} 1$	
460	2nd current ref. value [% I_N]	133	85	R / W		→ No.450	
461	2nd hysteresis \pm [% I_N]	134	86	R / W		→ No.401	
462	2nd delay [s]	135	87	R / W		→ No.402	
463	2nd signal = 1 if:	136	88	R / W		0.00 = $I < I_{ref} 2$ 1.00 = $I > I_{ref} 2$	
470	Signal = 1 if:	137	89	R / W		0.00 = $I < I_{max}$ 1.00 = $I > I_{max}$	
471	Delay [s]	138	8A	R / W		→ No.402	

Par. No.	Parameter	Index-No.		Format	Access	Meaning/ Value range		
		dec	hex					
CONTROL FUNCTIONS								
500	Deceleration monitoring	140	8C	4-byte BCD	R / W	0.00 = No	1.00 = Yes	
501	Frequency ref. value 3 [Hz]	139	8B		R / W	10.00...99.00 Step 1.00		
510	Motor n-monitoring 1	141	8D		R / W	0.00 = No	1.00 = Yes	
511	Response time 1 [s]	142	8E		R / W	0.10...9.00 Step 0.10		
512	Motor n-monitoring 2	143	8F		R / W	0.00 = No	1.00 = Yes	
513	Response time 2 [s]	144	90		R / W	→ Nr.511		
520	Regen. n-monitoring 1	145	91		R / W	0.00 = No	1.00 = Yes	
521	Response time 1 [s]	146	92		R / W	→ Nr.511		
522	Regen. n-monitoring 2	147	93		R / W	0.00 = No	1.00 = Yes	
523	Response time 2 [s]	148	94		R / W	→ Nr.511		
530	Mains voltage monitoring	149	95		R / W	0.00 = No	1.00 = Yes	
541	Motor protection 1	312	138		R / W	0.00 = OFF 2.00 = Switch off	1.00 = Warning	
542	Cooling type 1	314	13A		R / W	0.00 = fan-cooled	1.00 = ext. cooled	
543	Motor protection 2	313	139		R / W	→ No.541		
544	Cooling type 2	315	13B		R / W	→ No.542		
550	FRS alert	302	12E		8-byte	R / W	50.00...10 ⁸ -1 Step 1.00	
551	FRS lag error	304	130			R / W	100.00...10 ⁸ -1 Step 1.00	
552	Hold time [s]	260	104	4-byte BCD	R / W	1.00...99.00 Step 1.00		
553	Fault response	246	F6		R / W	0.00 = 0/1 signal 2.00 = stop	1.00 = coast 3.00 = rapid stop	
554	Positional tolerance slave	247	F7		R / W	10.00...32768.00 Step 1.00		
555	LED counter V11	248	F8		R / W	→ No.554		
556	Time constant pos. signal [ms]	251	FB		R / W	1.00...2000.00 Step 1.00		
557	Cable brake master-slave	268	10C		R / W	0.00 = No	1.00 = Yes	
560	Setpoint description P01	601	259		R / W	0.00 = No function 2.00 = Current 4.00 = Position high 6.00 = Max. Current 8.00 = Ramp 10.00 = Control word 2	1.00 = Speed 3.00 = Position low 5.00 = Max. Speed 7.00 = Slip 9.00 = Control word 1 11.00 = Speed [%]	
561	Actual value description PI1	604	25C	R / W	0.00 = No function 2.00 = Apparent current 4.00 = Position low 6.00 = Status word 1 8.00 = Speed [%]	1.00 = Speed 3.00 = Active current 5.00 = Position high 7.00 = Status word 2		
562	Setpoint description P02	602	25A	R / W	→ No.560			
563	Actual value description PI2	605	25D	R / W	→ No.561			
564	Setpoint description P03	603	25B	R / W	→ No.560			
565	Actual value description PI3	606	25E	R / W	→ No.561			
570	Enable fieldbus setpoints	607	25F	R / W	0.00 = No	1.00 = Yes		
571	Fieldbus time out [s]	608	260	R / W	0.01...650.00 Step 0.01			
572	Time out response	609	261	R / W	0.00 = Rapid stop 2.00 = Immediate switch-off 4.00 = Emergency stop/fault 5.00 = Immediate switch-off/fault 6.00 = Standard mode	1.00 = Emergency stop 3.00 = Rapid stop/fault 7.00 = No response		

Par. No.	Parameter	Index-No.		Format	Access	Meaning/ Value range	
		dec	hex				
TERMINAL ASSIGNMENT							
600	Terminal 42	150	96	4-byte BCD	R / W	0.00 = CCW/Stop	1.00 = Enable/Stop
601	Terminal 43	151	97		R / W	2.00 = Parameter set select.	3.00 = n11 (n21)
602	Terminal 47	152	98		R / W	4.00 = n12 (n22)	5.00 = Reset
603	Terminal 48	153	99		R / W	6.00 = Motor. pot. UP	7.00 = Motor. pot. DOWN
604	Terminal 49	154	9A		R / W	8.00 = /Deceleration mon.	9.00 = No function
605	Terminal 50	155	9B		R / W	10.00 = Ramp selection	11.00 = /Controller inhibit
606	Terminal 51	156	9C		R / W	12.00 = /External fault	13.00 = FRS zero point
607	Terminal 52	321	141		R / W	14.00 = FRS Control	15.00 = FRS slave start
608	Terminal 53	322	142		R / W	16.00 = CW/Stop	17.00 = No function
609	Terminal 54	323	143		R / W	18.00 = Free running slave	19.00 = /Hold controller
610	Terminal 61	157	9D	4-byte BCD	R / -	Brake released	
611	Terminal 62	158	9E		R / W	0.00 = MOVITRAC ready	1.00 = Rotating field on
612	Terminal 63	159	9F		R / W	2.00 = Rotating field off	3.00 = Brake applied
613	Terminal 64	160	A0		R / W	4.00 = Manual mode	5.00 = Parameter set
614	Terminal 69	324	144		R / W	6.00 = /lxt-Warning	7.00 = No function
615	Terminal 70	325	145		R / W	8.00 = 1st freq. ref.	9.00 = 2nd freq. ref.
616	Terminal 71	326	146		R / W	10.00 = No function	11.00 = Act. value=Setpoint
617	Terminal 72	327	147		R / W	12.00 = No function	13.00 = No function
					R / W	14.00 = No function	15.00 = 1st current ref.
					R / W	16.00 = 2nd current ref.	17.00 = I _{max}
				R / W	18.00 = /Fault delay	19.00 = /Fault	
				R / W	20.00 = /External fault	21.00 = /Current>>	
				R / W	22.00 = /U DC-link>>	23.00 = No function	
				R / W	24.00 = No function	25.00 = /lxt>>	
				R / W	26.00 = /Temperature>>	27.00 = No function	
				R / W	28.00 = Frequency skip	29.00 = /FRS alert	
				R / W	30.00 = /FRS lag error	31.00 = Slave in position	
				R / W	32.00 = /Fault BRC	33.00 = Brake released	
				R / W	34.00 = No function	35.00 = Zero speed	
				R / W	36.00 = Motor warning 1	37.00 = Motor warning 2	
				R / W	38.00 = In position	39.00 = IPOS output 1	
				R / W	40.00 = IPOS output 2	41.00 = IPOS output 3	
				R / W	42.00 = IPOS output 4	43.00 = IPOS output 5	
				R / W	44.00 = IPOS output 6	45.00 = IPOS output 7	
				R / W	46.00 = IPOS output 8		
630	Analog output 1 (TL.38)	162	A2	4-byte BCD	R / W	0.00 = Actual frequency	1.00 = Actual speed
					R / W	2.00 = No function	3.00 = Ramp
					R / W	4.00 = Motor voltage	5.00 = No function
					R / W	6.00 = lxt-value	7.00 = Apparent current
					R / W	8.00 = Frequency setpoint	
631	Factor analog output 1	163	A3		R / W	0.10...3.00 Step 0.01	
632	Analog output 2 (TL.39)	164	A4		R / W	→ No.630	
633	Factor analog output 2	165	A5		R / W	→ No.631	
634	Measurement output (TL.65)	274	112		R / W	→ No.630	
635	Factor measurement output	275	113		R / W	→ No.631	
640	Analog input (TL.32/33)	110	6E	R / W	0.00 = No function	1.00 = Setpoint n1	
641	Analog input (TL.36/37)	252	FC	R / W	0.00 = No function	1.00 = External current limit	

Par. No.	Parameter	Index-No.		Format	Access	Meaning/ Value range	
		dec	hex				
CONTROL FUNCTIONS							
710	Hoist function 1	170	AA	4-byte BCD	R / W	0.00 = No	1.00 = Yes
712	Hoist function 2	172	AC		R / W	0.00 = No	1.00 = Yes
720	Rapid start 1	174	AE		R / W	0.00 = No	1.00 = Yes
721	Excitation current 1 [%I _N]	175	AF		R / W	10.00...50.00 Step 1.00	
722	Duration 1 [s]	176	B0		R / W	3.00...180.00 Step 1.00	
723	Rapid start 2	177	B1		R / W	0.00 = No	1.00 = Yes
724	Excitation current 2 [%I _N]	178	B2		R / W	→ No.721	
725	Duration 2 [s]	179	B3		R / W	→ No.722	
730	DC braking 1	180	B4		R / W	0.00 = No	1.00 = Yes
731	DC braking time 1 [s]	181	B5		R / W	0.10...30.00 Step 0.10	
732	DC holding current 1 [%I _N]	182	B6		R / W	0.00...50.00 Step 1.00	
733	DC braking 2	183	B7		R / W	0.00 = No	1.00 = Yes
734	DC braking time 2 [s]	184	B8		R / W	→ No.731	
735	DC holding current 2 [%I _N]	185	B9		R / W	→ No.732	
740	DC heating current 1	186	BA		R / W	0.00 = No	1.00 = Yes
741	DC heating current 1 [%I _N]	187	BB		R / W	0.00...50.00 Step 1.00	
742	DC heating current 2	188	BC		R / W	0.00 = No	1.00 = Yes
743	DC heating current 2 [%I _N]	189	BD		R / W	→ No.741	
760	Synchronous operation	249	F9		R / W	0.00 = No	1.00 = Yes
761	MOVITRAC is	250	FA		R / W	0.00 = Slave	1.00 = Master
762	Master gear ratio factor	263	107	8-byte	R / W	1.00...3999999999.00 Step 1.00	
763	Slave gear ratio factor	265	109		R / W	→ No.762	
764	Mode	253	FD	4-byte BCD	R / W	0.00 = Mode 1 2.00 = Mode 3 4.00 = Mode 5 6.00 = Mode 7	1.00 = Mode 2 3.00 = Mode 4 5.00 = Mode 6
765	Slave counter	254	FE	8-byte	R / W	-99999999.00...-10.00 Step 1.00 10.00...99999999 Step 1.00	
766	Offset 1	256	100	4-byte BCD	R / W	-32767.00...-10.00 Step 1.00 10.00...32767.00 Step 1.00	
767	Offset 2	257	101		R / W	→ No.766	
768	Offset 3	258	102	R / W	→ No.766		
769	Controller KP factor	259	103	R / W	1.00...200.00 Step 1		
770	Operating mode	209	D1	R / W	0.00 = V/f mode 2.00 = Positioning control	1.00 = Speed control	
771	P gain	210	D2	R / W	0.10...60.00 Step 0.10		
772	Controller time constant [ms]	211	D3	R / W	0.00...500.00 Step 1.00		
773	Pulses per revolution	225	E1	R / W	0.00 = 128 2.00 = 512 4.00 = 2048	1.00 = 256 3.00 = 1024	
774	s x R preselection	235	EB	R / W	0.00 = No	1.00 = Yes	
777	P gain feedforward	262	106	R / W	0.00...60.00 Step 0.10		
778	Setpoint filter [ms]	208	D0	R / W	0.00...100.00 Step 1.00		
779	P gain hold control	261	105	R / W	→ No.777		

Par. No.	Parameter	Index-No.		Format	Access	Meaning/ Value range																																																																	
		dec	hex																																																																				
SPECIAL FUNCTIONS																																																																							
800	Parameter lock	202	CA	4-byte BCD	R / W	0.00 = No	1.00 = Yes																																																																
801	Save to EEPROM	236	EC		R / W	0.00 = On	1.00 = Off																																																																
802	User menu	270	10E		R/W	0.00 = On only with FBG 31	1.00 = Off																																																																
810	Software system	215	D7		R/-	The first digit of the part number (=8) is not transferred, it must be inserted afterward. Bits 0-4 are interpreted differently to allow an "X" to be transferred in the part number. When the value "A _{hex} " is transferred in this nibble, an "X" is displayed.																																																																	
812	EPROM fieldbus	214	D6		R/-																																																																		
						<table border="1" style="margin-left: auto; margin-right: auto;"> <tr> <td>2</td><td>1</td><td>1</td><td>2</td><td>3</td><td>4</td><td>1</td><td>1</td> </tr> <tr> <td colspan="8" style="text-align: center;">= 821 123 4.11</td> </tr> </table> <p>Byte 0 1 2 3</p>		2	1	1	2	3	4	1	1	= 821 123 4.11																																																							
2	1	1	2		3	4	1	1																																																															
= 821 123 4.11																																																																							
						<table border="1" style="margin-left: auto; margin-right: auto;"> <tr> <td>2</td><td>1</td><td>1</td><td>2</td><td>3</td><td>A</td><td>1</td><td>1</td> </tr> <tr> <td colspan="8" style="text-align: center;">= 821 123 X.11</td> </tr> </table> <p>Byte 0 1 2 3</p> <p style="text-align: right;">00735AXX</p>		2	1	1	2	3	A	1	1	= 821 123 X.11																																																							
2	1	1	2		3	A	1	1																																																															
= 821 123 X.11																																																																							
830	Factory setting	203	CB		R / W	0.00 = No	1.00 = Yes																																																																
831	Selection	328	148		R / W	0.00 = Standard	1.00 = US																																																																
841	Control mode	205	CD		R / W	0.00 = Standard 1.00 = Remote setpoint	2.00 = Remote control 3.00 = Fieldbus																																																																
842	Inverter address	206	CE	R / W	0.00...63.00 Step 1.00																																																																		
843	Response time [ms]	207	CF	R / W	0.00...200.00 Step 10.00																																																																		
850	Language	221	DD	R / W	0.00 = 1st language 2.00 = 3rd language	1.00 = 2nd language																																																																	
860	Auto-reset mode	168	A8	R / W	0.00 = No	1.00 = Yes																																																																	
861	Restart time [s]	167	A7	R / W	3.00...30.00 Step 1.00																																																																		
862	Keypad reset	166	A6	R / W	0.00 = No	1.00 = Yes																																																																	
870	Manual operation	196	C4	R / W	0.00 = No	1.00 = Yes																																																																	
870	Control word manual operation	197	C5	4-byte binary	R/-	<table border="1" style="margin-left: auto; margin-right: auto;"> <tr> <td colspan="4">Byte</td> </tr> <tr> <td>0</td><td>1</td><td>2</td><td>3</td> </tr> <tr> <td colspan="4" style="text-align: center;"> </td> </tr> <tr> <td colspan="4">Bit</td> </tr> <tr> <td>7</td><td>6</td><td>5</td><td>4</td><td>3</td><td>2</td><td>1</td><td>0</td> </tr> <tr> <td colspan="4"></td> <td>Running down</td> <td colspan="2"></td> <td></td> </tr> <tr> <td colspan="4"></td> <td>Running up</td> <td colspan="2"></td> <td></td> </tr> <tr> <td colspan="4"></td> <td>Rotational direction CW</td> <td colspan="2"></td> <td></td> </tr> <tr> <td colspan="4"></td> <td>Rotational direction CCW</td> <td colspan="2"></td> <td></td> </tr> <tr> <td colspan="4"></td> <td colspan="4" style="text-align: center;">"1" = active</td> </tr> </table> <p style="text-align: right;">00665AEN</p>		Byte				0	1	2	3					Bit				7	6	5	4	3	2	1	0					Running down								Running up								Rotational direction CW								Rotational direction CCW								"1" = active			
Byte																																																																							
0	1	2	3																																																																				
Bit																																																																							
7	6	5	4	3	2	1	0																																																																
				Running down																																																																			
				Running up																																																																			
				Rotational direction CW																																																																			
				Rotational direction CCW																																																																			
				"1" = active																																																																			
880	Master-slave	212	D4	4-byte BCD	R / W	0.00 = No	1.00 = Yes																																																																
881	MOVITRAC is	213	D5		R / W	0.00 = Slave	1.00 = Master																																																																
882	Weighting factor	226	E2		R / W	0.10...10.00 Step 0.01																																																																	
890	4-quadrant 1	194	C2		R / W	0.00 = No	1.00 = Yes																																																																
891	4-quadrant 2	195	C3		R / W	0.00 = No	1.00 = Yes																																																																

Par. No.	Parameter	Index-No.		Format	Access	Meaning/ Value range																																																																																																				
		dec	hex																																																																																																							
FUNCTION BITS AND UNIT STATUS																																																																																																										
-	Remote setpoint [Hz]	223	DF	4-byte BCD	R/W	0.00...400.00 Step 0.05																																																																																																				
-	Inverter type	271	10F		R/-	3000.00 = MOVITRAC 3000 3100.00 = MOVITRAC 31.. 5000.00 = MOVIDYN 5000																																																																																																				
-	Function bits MC31..	281	119	4-byte binary	R/W	<table border="1"> <tbody> <tr> <td rowspan="8">Byte 3</td> <td>0</td> <td>CW-rotation</td> <td>"1" = active</td> </tr> <tr> <td>1</td> <td>CCW-rotation</td> <td>"1" = active</td> </tr> <tr> <td>2</td> <td>Enable</td> <td>"1" = active</td> </tr> <tr> <td>3</td> <td>Parameter set selection</td> <td>"0" = Set 1</td> </tr> <tr> <td>4</td> <td>-</td> <td>"1" = Set 2</td> </tr> <tr> <td>5</td> <td>-</td> <td></td> </tr> <tr> <td>6</td> <td>Reset</td> <td>"1" = active</td> </tr> <tr> <td>7</td> <td>-</td> <td></td> </tr> <tr> <td rowspan="8">Byte 2</td> <td>0</td> <td>Controller inhibit</td> <td>"1" = active</td> </tr> <tr> <td>1</td> <td>-</td> <td></td> </tr> <tr> <td>2</td> <td>-</td> <td></td> </tr> <tr> <td>3</td> <td>-</td> <td></td> </tr> <tr> <td>4</td> <td>Ramp selection</td> <td>"0" = tx1 otherwise tx2</td> </tr> <tr> <td>5</td> <td>-</td> <td></td> </tr> <tr> <td>6</td> <td>-</td> <td></td> </tr> <tr> <td>7</td> <td>Hold control</td> <td>"1" = active</td> </tr> <tr> <td rowspan="8">Byte 1</td> <td>0</td> <td>-</td> <td></td> </tr> <tr> <td>1</td> <td>-</td> <td></td> </tr> <tr> <td>2</td> <td>-</td> <td></td> </tr> <tr> <td>3</td> <td>-</td> <td>Note on bytes 0-3:</td> </tr> <tr> <td>4</td> <td>-</td> <td>To permit the frequency inverter to</td> </tr> <tr> <td>5</td> <td>-</td> <td>control in REMOTE CONTROL mode,</td> </tr> <tr> <td>6</td> <td>-</td> <td>an enable must be present at the input</td> </tr> <tr> <td>7</td> <td>-</td> <td>terminals (factory set to TL. 43). All</td> </tr> <tr> <td rowspan="8">Byte 0</td> <td>0</td> <td>-</td> <td>subsequent bits are ORed with the</td> </tr> <tr> <td>1</td> <td>-</td> <td>terminal signals.</td> </tr> <tr> <td>2</td> <td>-</td> <td></td> </tr> <tr> <td>3</td> <td>-</td> <td></td> </tr> <tr> <td>4</td> <td>-</td> <td></td> </tr> <tr> <td>5</td> <td>-</td> <td></td> </tr> <tr> <td>6</td> <td>-</td> <td></td> </tr> <tr> <td>7</td> <td>-</td> <td></td> </tr> </tbody> </table>	Byte 3	0	CW-rotation	"1" = active	1	CCW-rotation	"1" = active	2	Enable	"1" = active	3	Parameter set selection	"0" = Set 1	4	-	"1" = Set 2	5	-		6	Reset	"1" = active	7	-		Byte 2	0	Controller inhibit	"1" = active	1	-		2	-		3	-		4	Ramp selection	"0" = tx1 otherwise tx2	5	-		6	-		7	Hold control	"1" = active	Byte 1	0	-		1	-		2	-		3	-	Note on bytes 0-3:	4	-	To permit the frequency inverter to	5	-	control in REMOTE CONTROL mode,	6	-	an enable must be present at the input	7	-	terminals (factory set to TL. 43). All	Byte 0	0	-	subsequent bits are ORed with the	1	-	terminal signals.	2	-		3	-		4	-		5	-		6	-		7	-	
Byte 3	0	CW-rotation	"1" = active																																																																																																							
	1	CCW-rotation	"1" = active																																																																																																							
	2	Enable	"1" = active																																																																																																							
	3	Parameter set selection	"0" = Set 1																																																																																																							
	4	-	"1" = Set 2																																																																																																							
	5	-																																																																																																								
	6	Reset	"1" = active																																																																																																							
	7	-																																																																																																								
Byte 2	0	Controller inhibit	"1" = active																																																																																																							
	1	-																																																																																																								
	2	-																																																																																																								
	3	-																																																																																																								
	4	Ramp selection	"0" = tx1 otherwise tx2																																																																																																							
	5	-																																																																																																								
	6	-																																																																																																								
	7	Hold control	"1" = active																																																																																																							
Byte 1	0	-																																																																																																								
	1	-																																																																																																								
	2	-																																																																																																								
	3	-	Note on bytes 0-3:																																																																																																							
	4	-	To permit the frequency inverter to																																																																																																							
	5	-	control in REMOTE CONTROL mode,																																																																																																							
	6	-	an enable must be present at the input																																																																																																							
	7	-	terminals (factory set to TL. 43). All																																																																																																							
Byte 0	0	-	subsequent bits are ORed with the																																																																																																							
	1	-	terminal signals.																																																																																																							
	2	-																																																																																																								
	3	-																																																																																																								
	4	-																																																																																																								
	5	-																																																																																																								
	6	-																																																																																																								
	7	-																																																																																																								

00666AEN

Par. No.	Parameter	Index-No.		Format	Access	Meaning/ Value range																																																																																																						
		dec	hex																																																																																																									
-	Inverter status MC31..	284	11C	4-byte binary	R/-	<table border="0"> <tr> <td rowspan="8">Byte 3</td> <td>0</td> <td>Brake chopper</td> <td>"0" = available</td> </tr> <tr> <td>1</td> <td>24 V supply</td> <td>"1" = 24 Volt</td> </tr> <tr> <td>2</td> <td>Signal type</td> <td>"0" = Current, "1" = Voltage</td> </tr> <tr> <td>3</td> <td>Parameter set</td> <td>"0" = Set 1, "1" = Set 2</td> </tr> <tr> <td>4</td> <td>Dir. of rotation</td> <td>"0" = CCW, "1" = CW</td> </tr> <tr> <td>5</td> <td>-</td> <td></td> </tr> <tr> <td>6</td> <td>-</td> <td></td> </tr> <tr> <td>7</td> <td>-</td> <td></td> </tr> <tr> <td rowspan="9">Byte 2</td> <td>0</td> <td rowspan="9">Option X20</td> <td>2 FF. (Fieldbus)</td> </tr> <tr> <td>1</td> <td>3 FME</td> </tr> <tr> <td>2</td> <td>4 FES</td> </tr> <tr> <td>3</td> <td>5 FIO</td> </tr> <tr> <td>4</td> <td>9 None</td> </tr> <tr> <td>5</td> <td rowspan="4">Option X21</td> <td>0 Short circuit</td> </tr> <tr> <td>6</td> <td>1 FEN</td> </tr> <tr> <td>7</td> <td>2 Binary inputs</td> </tr> <tr> <td>7</td> <td>3 FPI</td> </tr> <tr> <td rowspan="8">Byte 1</td> <td>0</td> <td rowspan="8">Inverter status</td> <td>9 None</td> </tr> <tr> <td>1</td> <td>0 Controller inhibit</td> </tr> <tr> <td>2</td> <td>1 No enable</td> </tr> <tr> <td>3</td> <td>2 Start magnetization</td> </tr> <tr> <td>4</td> <td>3 Stop magnetization</td> </tr> <tr> <td>5</td> <td>4 Rapid start</td> </tr> <tr> <td>6</td> <td>5 Heating current</td> </tr> <tr> <td>7</td> <td>6 DC braking</td> </tr> <tr> <td rowspan="8">Byte 0</td> <td>0</td> <td rowspan="8">Fault code (→ Par.-No. 060)</td> <td>7 DC holding current</td> </tr> <tr> <td>1</td> <td>8 sxR determination</td> </tr> <tr> <td>2</td> <td>9 DC braking available</td> </tr> <tr> <td>3</td> <td>10 Enable</td> </tr> <tr> <td>4</td> <td>11 Change rot. direction</td> </tr> <tr> <td>5</td> <td>12 Normal stop</td> </tr> <tr> <td>6</td> <td>13 Rapid stop</td> </tr> <tr> <td>7</td> <td>14 Hold control</td> </tr> <tr> <td></td> <td></td> <td></td> <td>15 Braking time</td> </tr> <tr> <td></td> <td></td> <td></td> <td>16 Reference travel</td> </tr> <tr> <td></td> <td></td> <td></td> <td>17 Positioning</td> </tr> <tr> <td></td> <td></td> <td></td> <td>18 Synchronous operation</td> </tr> <tr> <td></td> <td></td> <td></td> <td>19 Coast</td> </tr> </table>	Byte 3	0	Brake chopper	"0" = available	1	24 V supply	"1" = 24 Volt	2	Signal type	"0" = Current, "1" = Voltage	3	Parameter set	"0" = Set 1, "1" = Set 2	4	Dir. of rotation	"0" = CCW, "1" = CW	5	-		6	-		7	-		Byte 2	0	Option X20	2 FF. (Fieldbus)	1	3 FME	2	4 FES	3	5 FIO	4	9 None	5	Option X21	0 Short circuit	6	1 FEN	7	2 Binary inputs	7	3 FPI	Byte 1	0	Inverter status	9 None	1	0 Controller inhibit	2	1 No enable	3	2 Start magnetization	4	3 Stop magnetization	5	4 Rapid start	6	5 Heating current	7	6 DC braking	Byte 0	0	Fault code (→ Par.-No. 060)	7 DC holding current	1	8 sxR determination	2	9 DC braking available	3	10 Enable	4	11 Change rot. direction	5	12 Normal stop	6	13 Rapid stop	7	14 Hold control				15 Braking time				16 Reference travel				17 Positioning				18 Synchronous operation				19 Coast
Byte 3	0	Brake chopper	"0" = available																																																																																																									
	1	24 V supply	"1" = 24 Volt																																																																																																									
	2	Signal type	"0" = Current, "1" = Voltage																																																																																																									
	3	Parameter set	"0" = Set 1, "1" = Set 2																																																																																																									
	4	Dir. of rotation	"0" = CCW, "1" = CW																																																																																																									
	5	-																																																																																																										
	6	-																																																																																																										
	7	-																																																																																																										
Byte 2	0	Option X20	2 FF. (Fieldbus)																																																																																																									
	1		3 FME																																																																																																									
	2		4 FES																																																																																																									
	3		5 FIO																																																																																																									
	4		9 None																																																																																																									
	5		Option X21	0 Short circuit																																																																																																								
	6			1 FEN																																																																																																								
	7			2 Binary inputs																																																																																																								
	7			3 FPI																																																																																																								
Byte 1	0	Inverter status	9 None																																																																																																									
	1		0 Controller inhibit																																																																																																									
	2		1 No enable																																																																																																									
	3		2 Start magnetization																																																																																																									
	4		3 Stop magnetization																																																																																																									
	5		4 Rapid start																																																																																																									
	6		5 Heating current																																																																																																									
	7		6 DC braking																																																																																																									
Byte 0	0	Fault code (→ Par.-No. 060)	7 DC holding current																																																																																																									
	1		8 sxR determination																																																																																																									
	2		9 DC braking available																																																																																																									
	3		10 Enable																																																																																																									
	4		11 Change rot. direction																																																																																																									
	5		12 Normal stop																																																																																																									
	6		13 Rapid stop																																																																																																									
	7		14 Hold control																																																																																																									
			15 Braking time																																																																																																									
			16 Reference travel																																																																																																									
			17 Positioning																																																																																																									
			18 Synchronous operation																																																																																																									
			19 Coast																																																																																																									
-	PC time out [s]	285	11D	4-byte BCD	R/W	0.00...10.00 Step 0.10																																																																																																						
-	Stop setpoint 1, n2 [mV]	298	12A		R/-	0...25																																																																																																						
-	Start hysteresis 1, n2 [mV]	299	12B		R/-	0.1...5																																																																																																						
-	Stop setpoint 2, n2 [mV]	300	12C		R/-	0...25																																																																																																						
-	Start hysteresis 2, n2 [mV]	301	12D		R/-	0.1...5																																																																																																						
-	Output stage identification	306	132	R/-	<table border="0"> <tr> <td>01 = 31C008-503-4-00</td> <td>02 = 31C015-503-4-00</td> </tr> <tr> <td>03 = 31C022-503-4-00</td> <td>04 = 31C030-503-4-00</td> </tr> <tr> <td>05 = 31C040-503-4-00</td> <td>06 = 31C055-503-4-00</td> </tr> <tr> <td>07 = 31C075-503-4-00</td> <td>08 = 31C110-503-4-00</td> </tr> <tr> <td>09 = 31C150-503-4-00</td> <td>10 = 31C220-503-4-00</td> </tr> <tr> <td>11 = 31C300-503-4-00</td> <td>12 = 31C370-503-4-00</td> </tr> <tr> <td>13 = 31C450-503-4-00</td> <td>14 = 31C008-233-4-00</td> </tr> <tr> <td>15 = 31C015-233-4-00</td> <td>16 = 31C022-233-4-00</td> </tr> <tr> <td>17 = 31C037-233-4-00</td> <td>18 = 31C055-233-4-00</td> </tr> <tr> <td>19 = 31C075-233-4-00</td> <td></td> </tr> <tr> <td>31 = 31C005-503-4-00</td> <td>32 = 31C007-503-4-00</td> </tr> <tr> <td>33 = 31C011-503-4-00</td> <td>34 = 31C014-503-4-00</td> </tr> <tr> <td>41 = 31C005-233-4-00</td> <td>43 = 31C011-233-4-00</td> </tr> </table>	01 = 31C008-503-4-00	02 = 31C015-503-4-00	03 = 31C022-503-4-00	04 = 31C030-503-4-00	05 = 31C040-503-4-00	06 = 31C055-503-4-00	07 = 31C075-503-4-00	08 = 31C110-503-4-00	09 = 31C150-503-4-00	10 = 31C220-503-4-00	11 = 31C300-503-4-00	12 = 31C370-503-4-00	13 = 31C450-503-4-00	14 = 31C008-233-4-00	15 = 31C015-233-4-00	16 = 31C022-233-4-00	17 = 31C037-233-4-00	18 = 31C055-233-4-00	19 = 31C075-233-4-00		31 = 31C005-503-4-00	32 = 31C007-503-4-00	33 = 31C011-503-4-00	34 = 31C014-503-4-00	41 = 31C005-233-4-00	43 = 31C011-233-4-00																																																																													
01 = 31C008-503-4-00	02 = 31C015-503-4-00																																																																																																											
03 = 31C022-503-4-00	04 = 31C030-503-4-00																																																																																																											
05 = 31C040-503-4-00	06 = 31C055-503-4-00																																																																																																											
07 = 31C075-503-4-00	08 = 31C110-503-4-00																																																																																																											
09 = 31C150-503-4-00	10 = 31C220-503-4-00																																																																																																											
11 = 31C300-503-4-00	12 = 31C370-503-4-00																																																																																																											
13 = 31C450-503-4-00	14 = 31C008-233-4-00																																																																																																											
15 = 31C015-233-4-00	16 = 31C022-233-4-00																																																																																																											
17 = 31C037-233-4-00	18 = 31C055-233-4-00																																																																																																											
19 = 31C075-233-4-00																																																																																																												
31 = 31C005-503-4-00	32 = 31C007-503-4-00																																																																																																											
33 = 31C011-503-4-00	34 = 31C014-503-4-00																																																																																																											
41 = 31C005-233-4-00	43 = 31C011-233-4-00																																																																																																											

00667AEN



Par. No.	Parameter	Index-No.		Format	Access	Meaning/ Value range
		dec	hex			
FAULT MEMORY						
-	Fault t-0 DC-link voltage [V]	400	190	4-byte BCD	R/-	
-	Fault t-0 Heat sink temp. [°C]	402	192		R/-	
-	Fault t-0 Frequency [Hz]	403	193		R/-	
-	Fault t-0 Apparent current [%I _N]	404	194		R/-	
-	Fault t-0 Utilization Ixt [%]	406	196		R/-	
-	Fault t-0 Inverter status	407	197	4-byte binary	R/-	→ Inverter status MC31 Index-Nr. 284 _{dec} , Byte 2 and 3
-	Fault t-0 Terminal status	408	198	4-byte BCD	R/-	
-	Fault t-1 DC-link voltage [V]	409	199		R/-	
-	Fault t-1 Kühlkörpertemp. [°C]	411	19B		R/-	
-	Fault t-1 Frequency [Hz]	412	19C		R/-	
-	Fault t-1 Apparent current [%I _N]	413	19D		R/-	
-	Fault t-1 Utilization Ixt [%]	415	19F	R/-		
-	Fault t-1 Inverter status	416	1A0	4-byte binary	R/-	→ Inverter status MC31 Index-Nr. 284 _{dec} , Byte 2 and 3
-	Fault t-1 Terminal status	417	1A1	4-byte BCD	R/-	
-	Fault t-2 DC-link voltage [V]	418	1A2		R/-	
-	Fault t-2 Heat sink temp. [°C]	420	1A4		R/-	
-	Fault t-2 Frequency [Hz]	421	1A5		R/-	
-	Fault t-2 Apparent current [%I _N]	422	1A6		R/-	
-	Fault t-2 Utilization Ixt [%]	424	1A8	R/-		
-	Fault t-2 Inverter status	425	1A9	4-byte binary	R/-	→ Inverter status MC31 Index-Nr. 284 _{dec} , Byte 2 and 3
-	Fault t-2 Terminal status	426	1AA	4-byte BCD	R/-	
-	Fault t-3 DC-link voltage [V]	427	1AB		R/-	
-	Fault t-3 Heat sink temp. [°C]	429	1AD		R/-	
-	Fault t-3 Frequency [Hz]	430	1AE		R/-	
-	Fault t-3 Apparent current [%I _N]	431	1AF		R/-	
-	Fault t-3 Utilization Ixt [%]	433	1B1	R/-		
-	Fault t-3 Inverter status	434	1B2	4-byte binary	R/-	→ Inverter status MC31 Index-Nr. 284 _{dec} , Byte 2 and 3
-	Fault t-3 Terminal status	435	1B3	4-byte BCD	R/-	
-	Fault t-4 DC-link voltage [V]	436	1B4		R/-	
-	Fault t-4 Heat sink temp. [°C]	438	1B6		R/-	
-	Fault t-4 Frequency [Hz]	439	1B7		R/-	
-	Fault t-4 Apparent current [%I _N]	440	1B8		R/-	
-	Fault t-4 Utilization Ixt [%]	442	1BA	R/-		
-	Fault t-4 Inverter status	443	1BB	4-byte binary	R/-	→ Inverter status MC31 Index-No. 284 _{dec} , Byte 2 and 3
-	Fault t-4 Terminal status	444	1BC	4-byte BCD	R/-	

Par. No.	Parameter	Index-No.		Format	Access	Meaning/ Value range
		dec	hex			
IPOS PARAMETERS						
-	Reference speed 1 [1/min]	700	2BC	4-byte BCD	R/W	0.00...5000.00 Step 1.00
-	Reference speed 2 [1/min]	701	2BD		R/W	0.00...5000.00 Step 1.00
-	Reference travel type	702	2BE		R/W	0.00 = Type 0 1.00 = Type 1 2.00 = Type 2 3.00 = Type 3 4.00 = Type 4 5.00 = Type 5
-	Loading/Saving IPOS-programs	704	2C0		R/W	0.00 = No function 1.00 = Save to EEPROM 2.00 = Load from EEPROM
-	IPOS operating mode	705	2C1		R/W	0.00 = Stop 1.00 = Start 2.00 = Breakpoint 3.00 = Single step mode 4.00 = Manual mode 5.00 = Half
-	IPOS Instruction pointer	706	2C2		R/-	0.00...255.00 Step 1.00
-	IPOS Breakpoint	707	2C3		R/W	0.00...255.00 Step 1.00
-	Position window [Inc]	708	2C4		R/W	0.00...32767.00 Step 1.00
-	Override	709	2C5		R/W	0.00 = Off 1.00 = On
-	Teach terminal	710	2C6		R/W	0.00...15.00 Step 1.00
-	Manual mode	711	2C7		R/W	0.00 = x control 1.00 = n control
-	Time out period [ms]	712	2C8		R/W	0.00...32767.00 Step 1.00
-	n-setpoint	713	2C9		R/W	0.00...3000.00
-	Code pointer	714	2CA		R/W	0.00...255.00 Step 1.00
-	Data pointer	715	2CB		R/W	0.00...255.00 Step 1.00
-	Gain x controller	716	2CC		R/W	0.10...32.00 Step 0.05
-	Positioning ramp [s]	717	2CD		R/W	0.00...0.50 Step 0.02 0.50...3.00 Step 0.10 3.00...10.00 Step 0.50
-	Travel speed CW [1/min]	718	2CE		R/W	0.00...5000.00 Step 1.00
-	Travel speed CCW [1/min]	719	2CF		R/W	0.00...5000.00 Step 1.00
-	Axis referencing	720	2D0		R/W	0.00 = No 1.00 = Yes
-	Reference point defined	721	2D1	R/W	0.00 = No 1.00 = Yes	
-	IPOS Fieldbus mode	722	2D2	R/W	0.00 = Bus position setpoint not used 1.00 = Bus position setpoint used as manual mode setpoint 2.00 = GOPA command is using the bus position setpoint	
-	Feedforward [%]	723	2D3	R/W	-150.00...+150.00 Step 0.10	
-	Reference offset [Inc]	1000	3E8	8-byte	R/W	$-2^{31} \dots +2^{31} - 1$ Step 1.00
-	Software limit switch CW [Inc]	1001	3E9		R/W	$-2^{31} \dots +2^{31} - 1$ Step 1.00
-	Software limit switch CCW [Inc]	1002	3EA		R/W	$-2^{31} \dots +2^{31} - 1$ Step 1.00
-	Lag error window [Inc]	1003	3EB		R/W	0.00... $2^{31} - 1$ Step 1.00
-	x setpoint [Inc]	1004	3EC		R/W	$-2^{31} \dots +2^{31} - 1$ Step 1.00
-	Actual position [Inc]	1009	3F1		R/-	$-2^{31} \dots +2^{31} - 1$ Step 1.00
-	Code value	1010	3F2		R/W	$-2^{31} \dots +2^{31} - 1$ Step 1.00
-	Data value	1011	3F3		R/W	$-2^{31} \dots +2^{31} - 1$ Step 1.00
-	PC position setpoint [Inc]	1012	3F4		R/W	$-2^{31} \dots +2^{31} - 1$ Step 1.00
-	Lag distance [Inc]	1017	3F9		R/-	0.00... $2^{31} - 1$ Step 1.00

Conversion list Index → Parameter:

Index No.		Parameter No.
dec	hex	
0	0	000
1	1	011
2	2	010
4	4	001
5	5	020
6	6	021
8	8	060
9	9	061
10	A	062
11	B	063
12	C	064
13	D	030/031/032 040/043
17	11	004
18	12	003
21	15	100
22	16	101
23	17	102
24	18	110
25	19	120
26	1A	121
27	1B	130
28	1C	140
29	1D	122
30	1E	150
31	1F	151
32	20	152
33	21	153
34	22	154
35	23	160
36	24	161
37	25	162
38	26	163
39	27	170
40	28	171
41	29	172
42	2A	173
79	4F	200
80	50	201
81	51	202
82	52	210
83	53	211
84	54	212
85	55	220
86	56	221
87	57	222
88	58	250
89	59	251
90	5A	230
91	5B	231
92	5C	232
96	60	260

Index No.		Parameter No.
dec	hex	
97	61	261
98	62	111
102	66	320
103	67	321
104	68	322
105	69	323
106	6A	324
110	6E	640
111	6F	340
112	70	341
113	71	342
114	72	343
115	73	344
116	74	350
117	75	400
118	76	401
119	77	402
120	78	410
121	79	411
122	7A	412
123	7B	403
124	7C	413
126	7E	430
127	7F	431
129	81	450
130	82	451
131	83	452
132	84	453
133	85	460
134	86	461
135	87	462
136	88	463
137	89	470
138	8A	471
139	8B	501
140	8C	500
141	8D	510
142	8E	511
143	8F	512
144	90	513
145	91	520
146	92	521
147	93	522
148	94	523
149	95	530
150	96	600
151	97	601
152	98	602
153	99	603
154	9A	604
155	9B	605
156	9C	606

Index No.		Parameter No.
dec	hex	
157	9D	610
158	9E	611
159	9F	612
160	A0	613
162	A2	630
163	A3	631
164	A4	632
165	A5	633
166	A6	862
167	A7	861
168	A8	860
170	AA	710
172	AC	712
174	AE	720
175	AF	721
176	B0	722
177	B1	723
178	B2	724
179	B3	725
180	B4	730
181	B5	731
182	B6	732
183	B7	733
184	B8	734
185	B9	735
186	BA	740
187	BB	741
188	BC	742
189	BD	743
194	C2	890
195	C3	891
196	C4	870
197	C5	870
202	CA	800
203	CB	830
205	CD	841
206	CE	842
207	CF	843
208	D0	778
209	D1	770
210	D2	771
211	D3	772
212	D4	880
213	D5	881
214	D6	812
215	D7	810
221	DD	850
223	DF	Remote-Setpoint
225	E1	773
226	E2	882
230	E6	123
231	E7	124

Index No.		Parameter No.
dec	hex	
232	E8	131
233	E9	141
234	EA	125
235	EB	774
236	EC	801
237	ED	050/051
246	F6	553
247	F7	554
248	F8	555
249	F9	760
250	FA	761
251	FB	556
252	FC	641
253	FD	764
254	FE	765
256	100	766
257	101	767
258	102	768
259	103	769
260	104	552
261	105	779
262	106	777
263	107	762
265	109	763
267	10B	328
268	10C	557
269	10D	348
270	10E	802
271	10F	Inverter type
272	110	325
273	111	345
274	112	634
275	113	635
277	115	326
278	116	327
279	117	346
280	118	347
281	119	Function bits
284	11C	Inverter status
285	11D	PC Time out
286	11E	329
287	11F	349
291	123	180
292	124	181
293	125	182
294	126	183
295	127	184
296	128	185
298	12A	Stop-Setpoint 1
299	12B	Start-Hysteresis 1
300	12C	Stop-Setpoint 2
301	12D	Start-Hysteresis 2
302	12E	550
304	130	551

Index No.		Parameter No.
dec	hex	
306	132	Output recognition
308	134	022
309	135	023
310	136	310
311	137	330
312	138	541
313	139	543
314	13A	542
315	13B	544
321	141	607
322	142	608
323	143	609
324	144	614
325	145	615
326	146	616
327	147	617
328	148	831
329	149	311
330	14A	331
400	190	Fault memory (→ Pg. 34)
402	192	
403	193	
404	194	
406	196	
407	197	
408	198	
409	199	
411	19B	
412	19C	
413	19D	
415	19F	
416	1A0	
417	1A1	
418	1A2	
420	1A4	
421	1A5	
422	1A6	
424	1A8	
425	1A9	
426	1AA	
427	1AB	
429	1AD	
430	1AE	
431	1AF	
433	1B1	
434	1B2	
435	1B3	
436	1B4	
438	1B6	
439	1B7	
440	1B8	
442	1BA	
443	1BB	
444	1BC	

Index No.		Parameter No.
dec	hex	
600	258	070
601	259	560
602	25A	562
603	25B	564
604	25C	561
605	25D	563
606	25E	565
607	25F	570
608	260	571
609	261	572
610	262	071
611	263	072
612	264	073
613	265	074
614	266	076
615	267	078
616	268	075
617	269	077
618	26A	079
700	2BC	IPOS Parameters (→ Pg. 35)
701	2BD	
702	2BE	
704	2C0	
705	2C1	
706	2C2	
707	2C3	
708	2C4	
709	2C5	
710	2C6	
711	2C7	
712	2C8	
713	2C9	
714	2CA	
715	2CB	
716	2CC	
717	2CD	
718	2CE	
719	2CF	
720	2D0	
721	2D1	
722	2D2	
723	2D3	
1000	3E8	
1001	3E9	
1002	3EA	
1003	3EB	
1004	3EC	
1009	3F1	
1010	3F2	
1011	3F3	
1012	3F4	
1017	3F9	

**We are available, wherever you need us.
Worldwide.**

SEW-EURODRIVE right around the globe is
your competent partner in matters of power

transmission with manufacturing and assem-
bly plants in most major industrial countries.



**SEW
EURODRIVE**

SEW-EURODRIVE GmbH & Co · P.O.Box 30 23 · D-76642 Bruchsal/Germany
Tel. +49-7251-75-0 · Fax +49-7251-75-19 70 · Telex 7 822 391
<http://www.SEW-EURODRIVE.com> · sew@sew-eurodrive.com